



SOLUZIONI RADIANTI  
IN FIBRA DI CARBONIO

# AZIENDA



## Soluzioni radianti elettriche su misura

che uniscono le performance della fibra di carbonio a materiali nano-tecnologici a basso spessore, per garantire il massimo livello di comfort, benessere e sicurezza negli ambienti.

SOLUZIONI

**SGHIACCIANTI  
PER ESTERNI**

SOLUZIONI

**RISCALDANTI  
PER INTERNI**

SOLUZIONI

**ANTI UMIDITÀ  
DI RISALITA**



# FIBRA DI CARBONIO

Il nucleo radiante dei nostri sistemi

**Leggera e Flessibile**

Ignifuga

**Inossidabile**

Inalterabile nel tempo

Prestazioni costanti tra i  $-40^{\circ}\text{C}$  e i  $+300^{\circ}\text{C}$

**Nessuna manutenzione richiesta**

**100% Riciclabile**

SOLUZIONI RADIANTI IN FIBRA DI CARBONIO



## SISTEMA BREVETTATO



Trasmissione di energia termica tramite l'impiego di fibra di carbonio per sistemi elettrici ad irraggiamento.

[www.lab44.it](http://www.lab44.it)



# IRRAGGIAMENTO

**IMPULSO  
ELETTRICO**

**SISTEMI  
LAB44**

**RAGGI  
INFRAROSSI  
FIR**

**INTERNI**

**Nessun campo  
magnetico nocivo**

**Come i raggi solari**  
Lunghezza d'onda  $9.0\mu\text{m}$ ,  
ottimale per trasmissione di  
calore al corpo umano

**Calore salubre senza  
spostamento d'aria**

**ESTERNI**

**Efficaci e senza la necessità  
di interventi invasivi**

**Nessun rumore**

Metodo di trasmissione del calore che avviene senza contatto o resistenza.

**L'energia termica si trasmette ai corpi (umani o solidi) che la traducono in calore.**

# SISTEMI ELETTRICI



## ALTERNATIVA ECOLOGICA E SOSTENIBILE

0 emissioni nell'ambiente

Sfruttano l'impianto fotovoltaico



## ACCENSIONE A NECESSITÀ

In funzione solo con ambienti in utilizzo negli interni. Azionati da sonde, interruttori o cronotermostati per sghiaccianti e anti-umidità.



## NESSUNA MODIFICA AGLI IMPIANTI

Si connettono direttamente all'impianto elettrico come una lampadina.

SOLUZIONI RADIANTI IN FIBRA DI CARBONIO



[www.lab44.it](http://www.lab44.it)

**LAB  
44**

# PRODOTTI RADIANTI

## SISTEMI RISCALDANTI A PAVIMENTO PER INTERNI



Riscaldano efficacemente piccoli e grandi spazi, irraggiando in modo uniforme le persone presenti sulla pavimentazione.

# MATERASSINO RADIANTE SOTTO PAVIMENTO FLOTTANTE

## **SPESSORE MINIMO**

Ideale anche per applicazioni sopra la  
pavimentazione esistente

## **POSA DIRETTA**

Installazione della nuova pavimentazione  
flottante direttamente sopra al  
materassino radiante

SOLUZIONI RADIANTI IN FIBRA DI CARBONIO

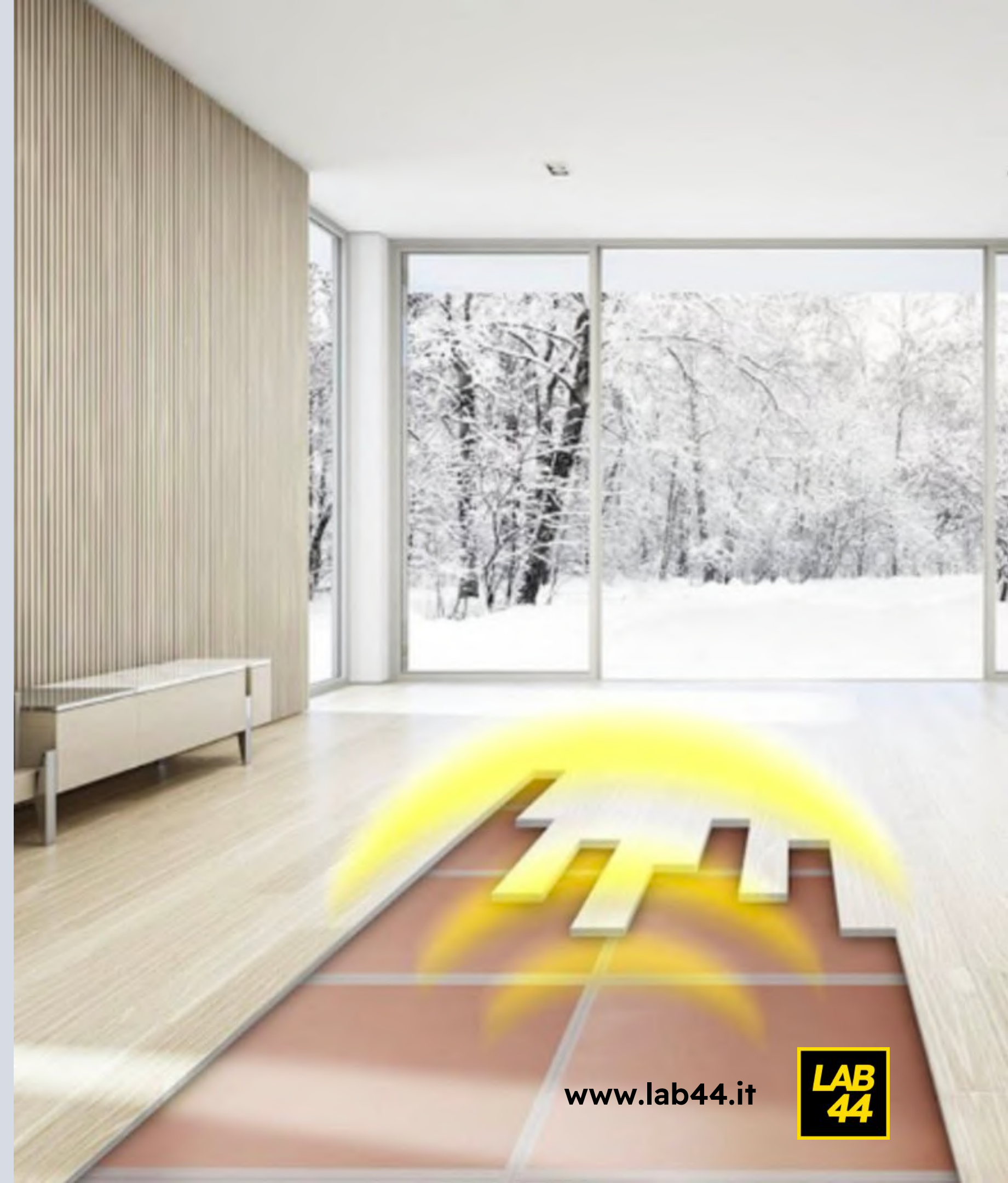

[www.lab44.it](http://www.lab44.it)



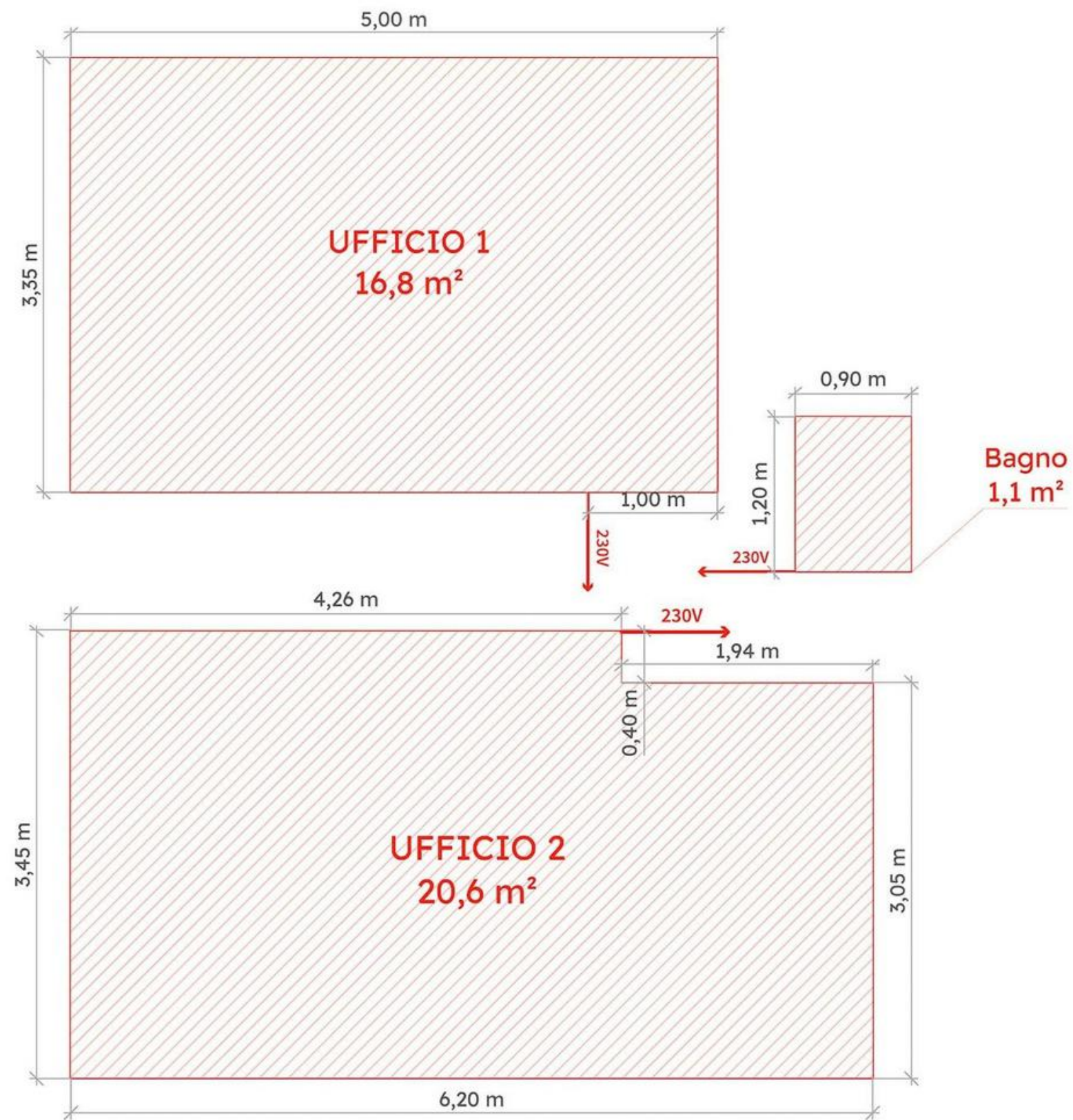

## CASE HISTORY

# RISCALDAMENTO UFFICI

Realizzazione su misura

**Partner:** Ronzani Impianti

**Località:** Asiago Vicenza





SOLUZIONI RADIANTI IN FIBRA DI CARBONIO

[www.lab44.it](http://www.lab44.it)



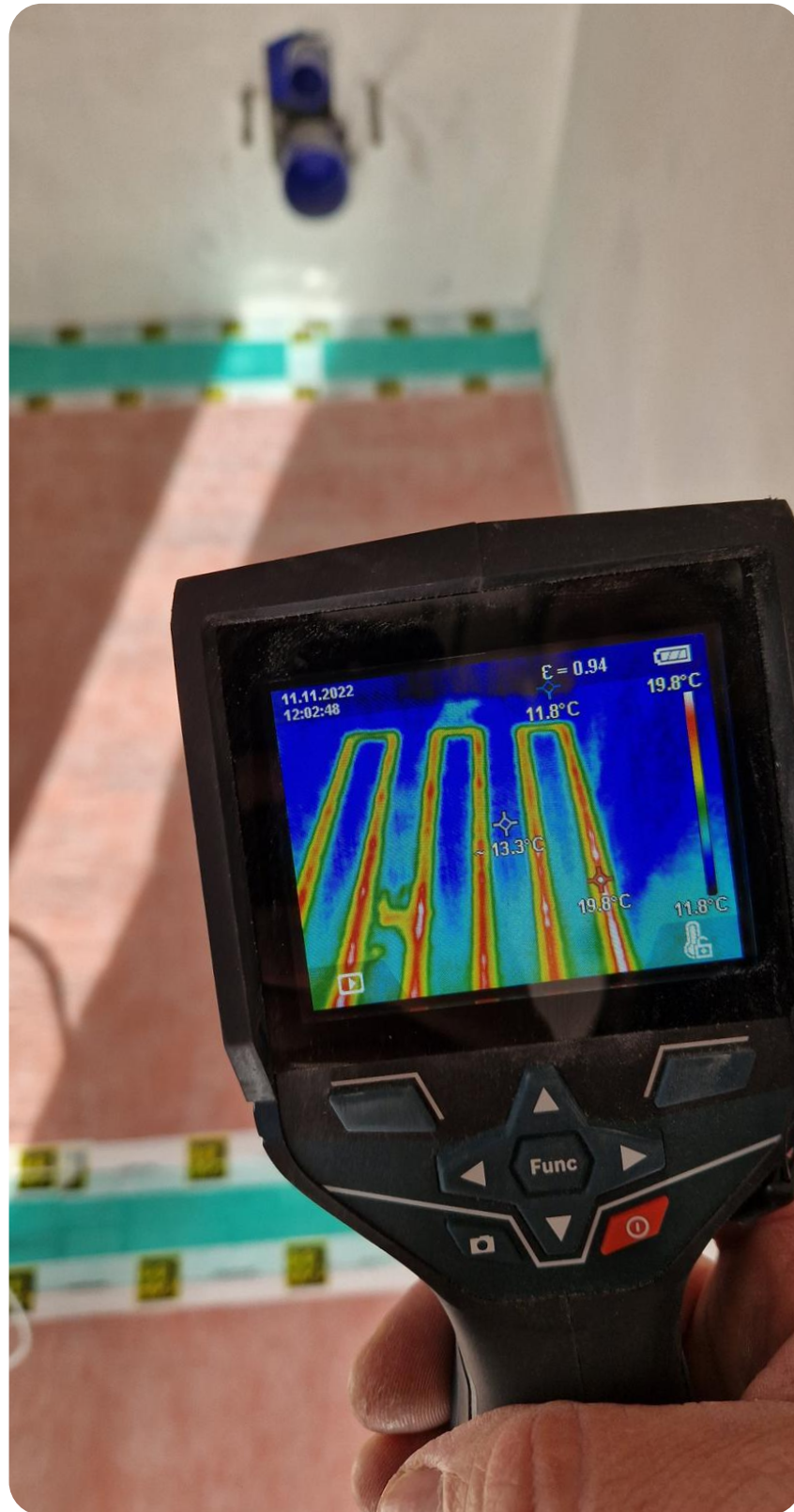

SOLUZIONI RADIANTI IN FIBRA DI CARBONIO

[www.lab44.it](http://www.lab44.it)





## CASE HISTORY

# RISCALDAMENTO BOX UFFICIO

Realizzazione su misura

Località: Padova

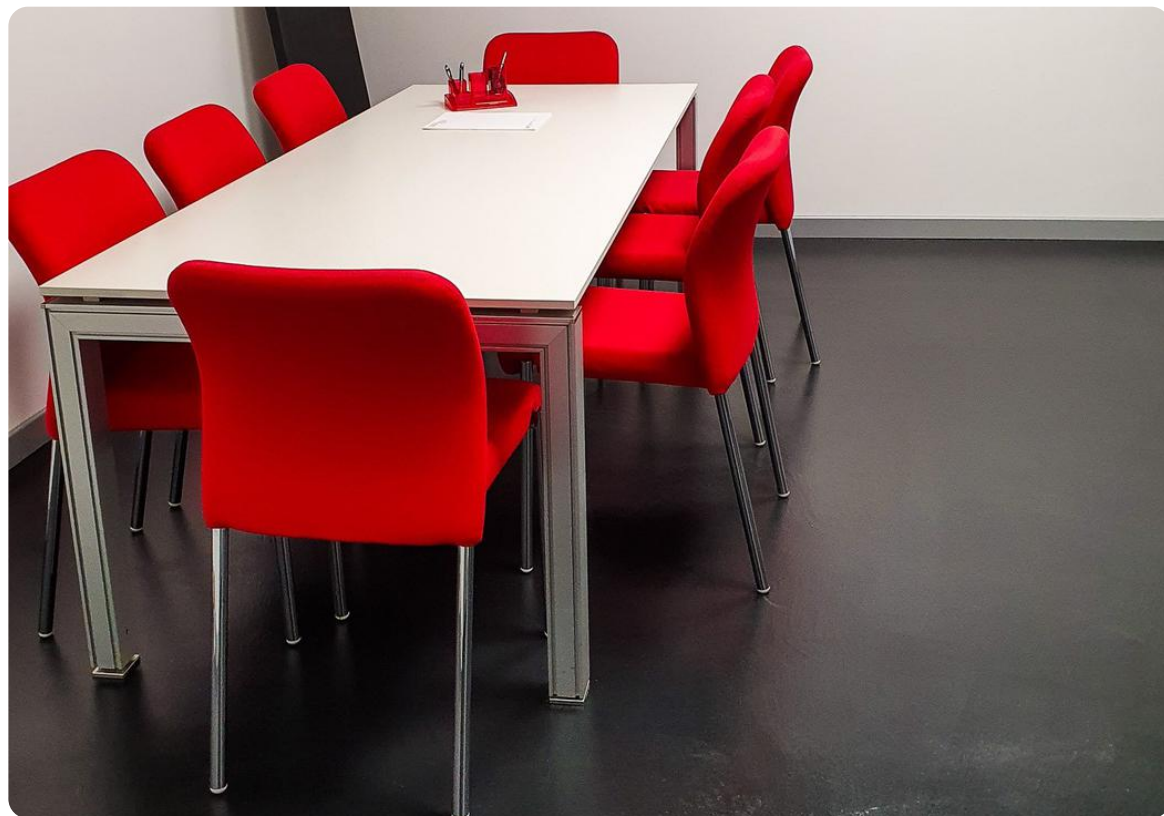
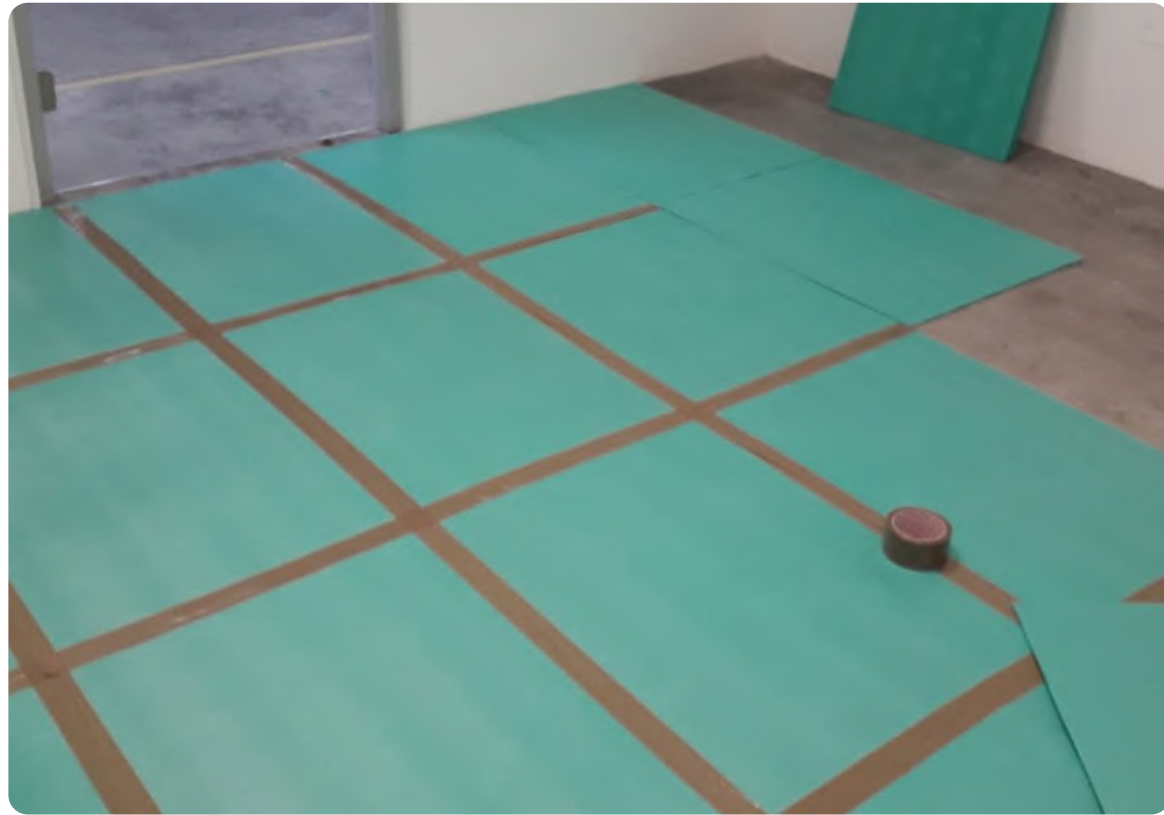

SOLUZIONI RADIANTI IN FIBRA DI CARBONIO

[www.lab44.it](http://www.lab44.it)





## CASE HISTORY

# RISCALDAMENTO AREA FITNESS SOPRAELEVATA

Realizzazione su misura

Località: Vicenza

SOLUZIONI RADIANTI IN FIBRA DI CARBONIO

[www.lab44.it](http://www.lab44.it)



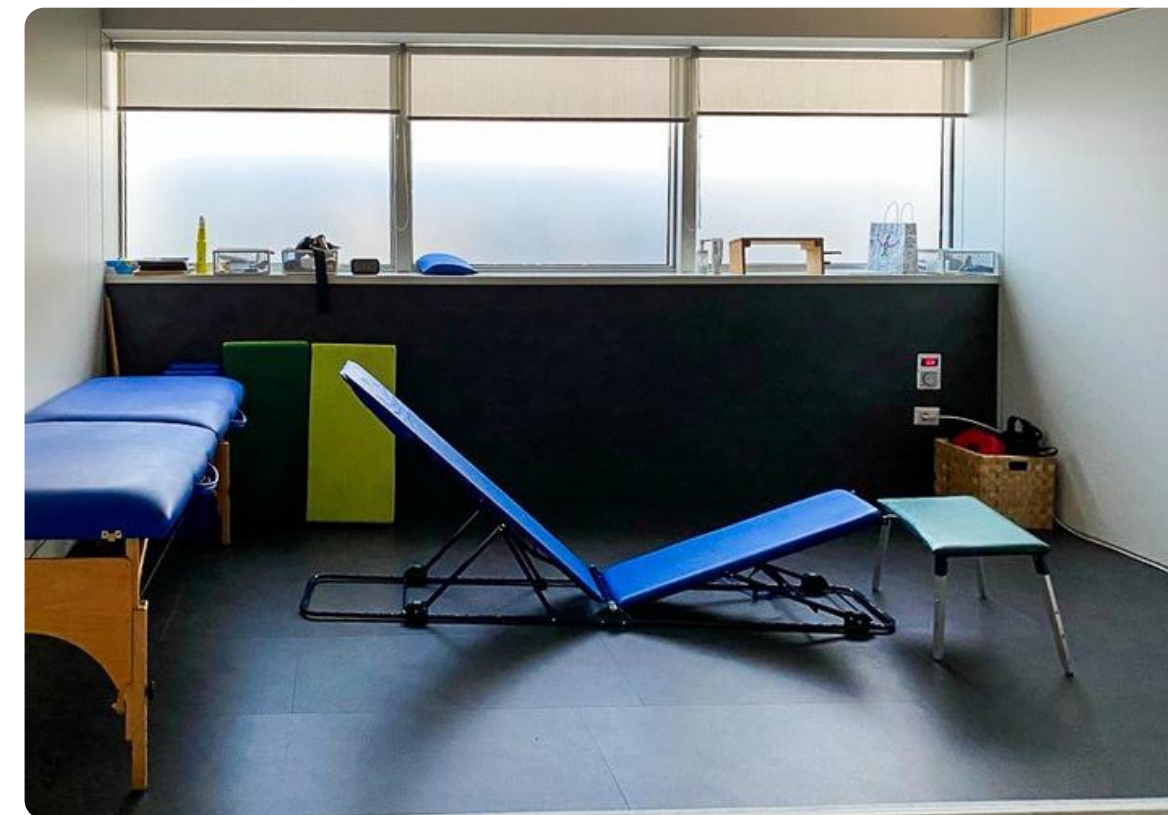
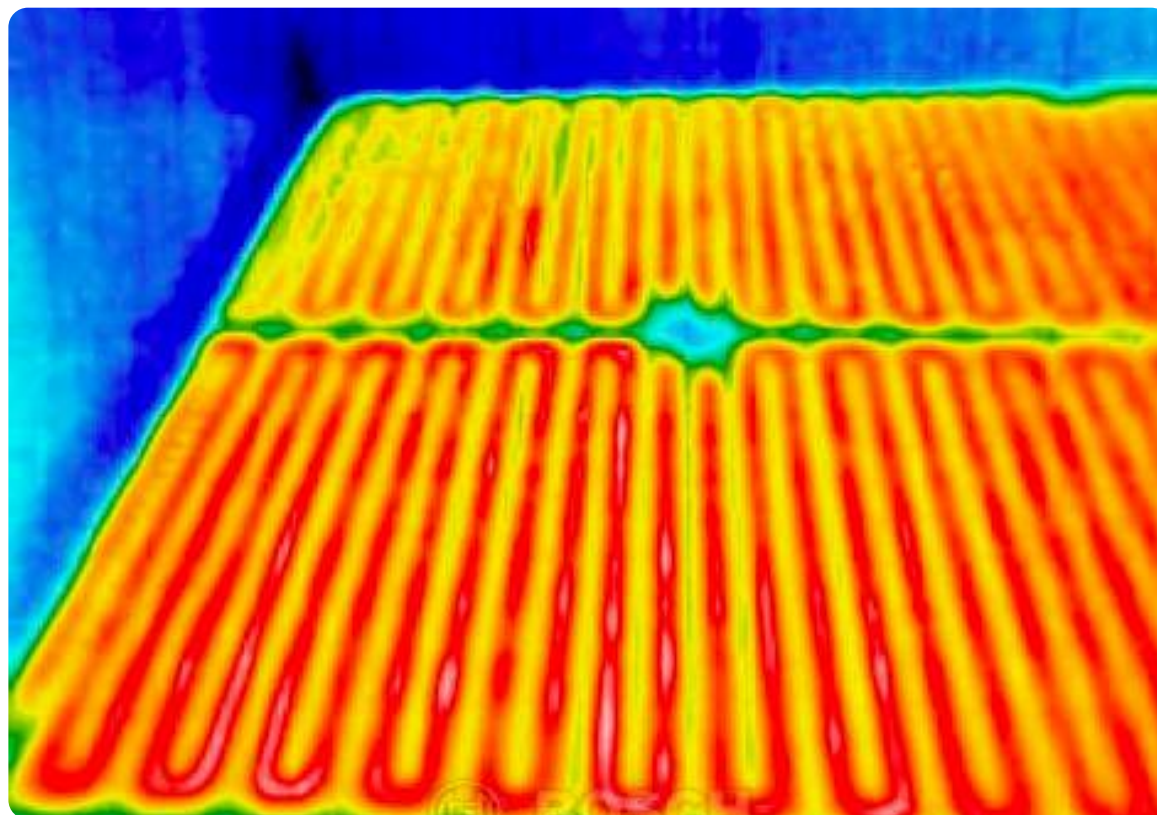
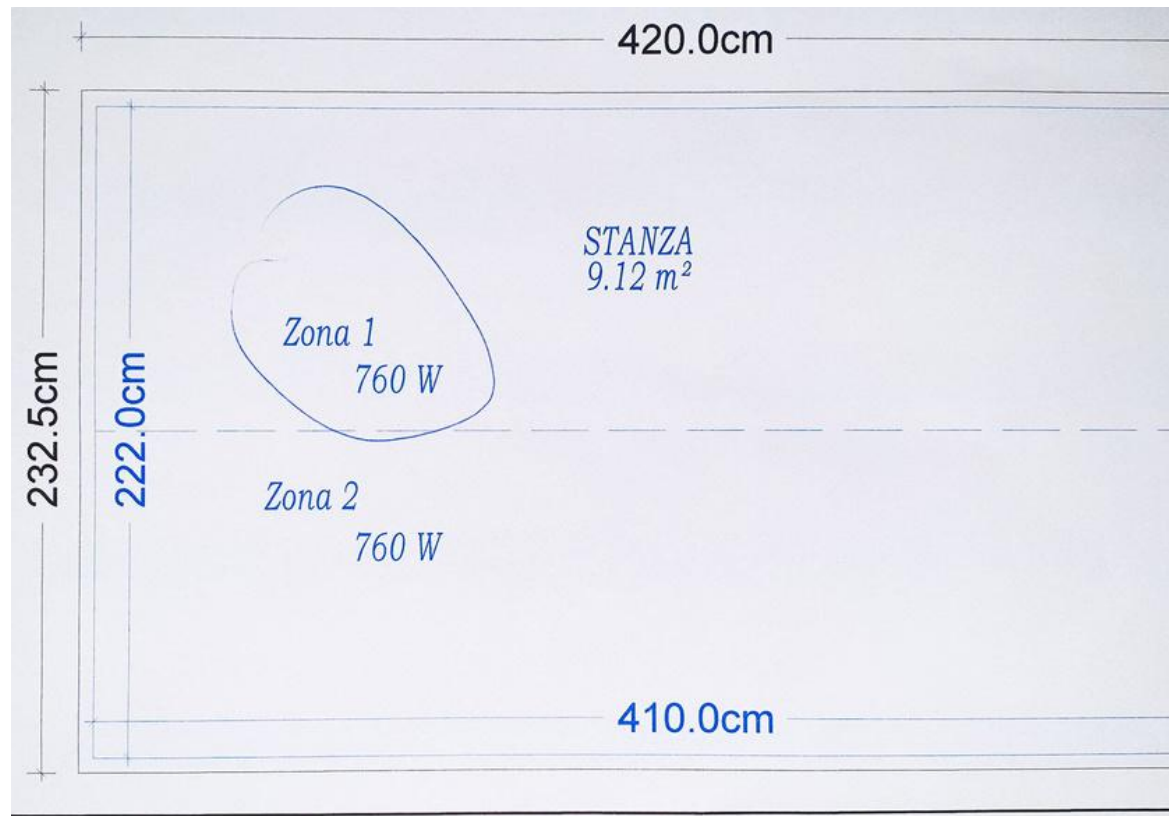

SOLUZIONI RADIANTI IN FIBRA DI CARBONIO

[www.lab44.it](http://www.lab44.it)



# RETE RADIANTE SOTTO MASSETTI E PAVIMENTI IN CERAMICA

## **SPESSORE MINIMO**

Ideale per applicazione anche sopra la  
pavimentazione esistente

## **POSA SOTTO MASSETTO**

SOLUZIONI RADIANTI IN FIBRA DI CARBONIO



[www.lab44.it](http://www.lab44.it)





## CASE HISTORY

# RISCALDAMENTO UFFICI DIREZIONALI

**Realizzazione su misura**

**Committente:** O.M. P - Officine  
Mazzocco Pagnoni

**Località:** Argelato - Bologna



SOLUZIONI RADIANTI IN FIBRA DI CARBONIO

[www.lab44.it](http://www.lab44.it)





# PROGETTO PIANO TERRA

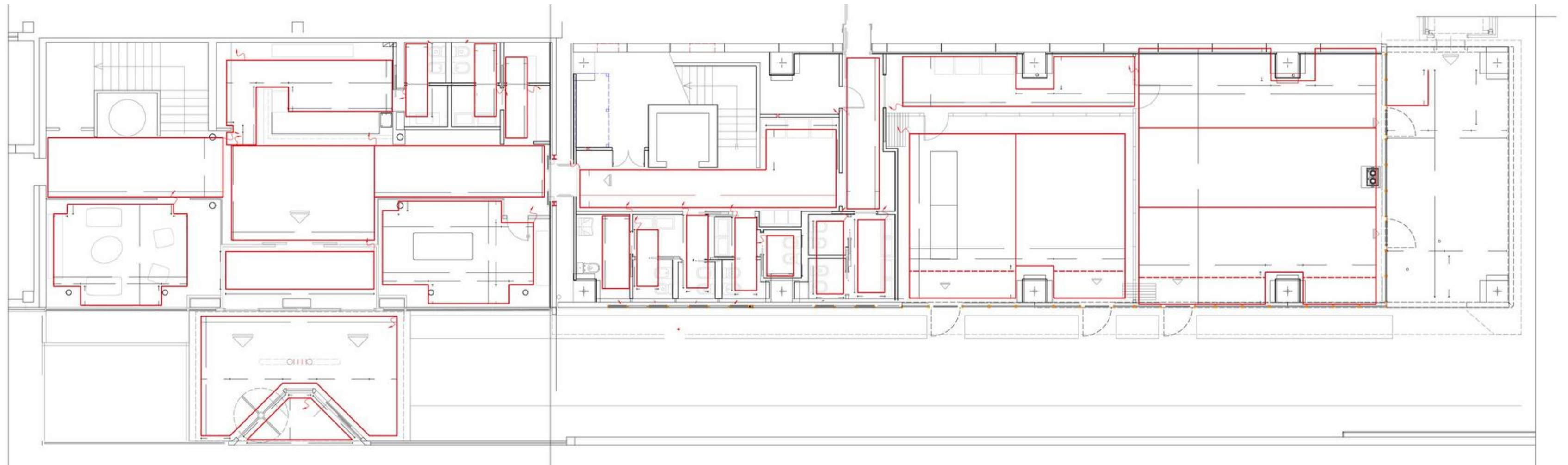

SOLUZIONI RADIANTI IN FIBRA DI CARBONIO

[www.lab44.it](http://www.lab44.it)



# PROGETTO PIANO PRIMO

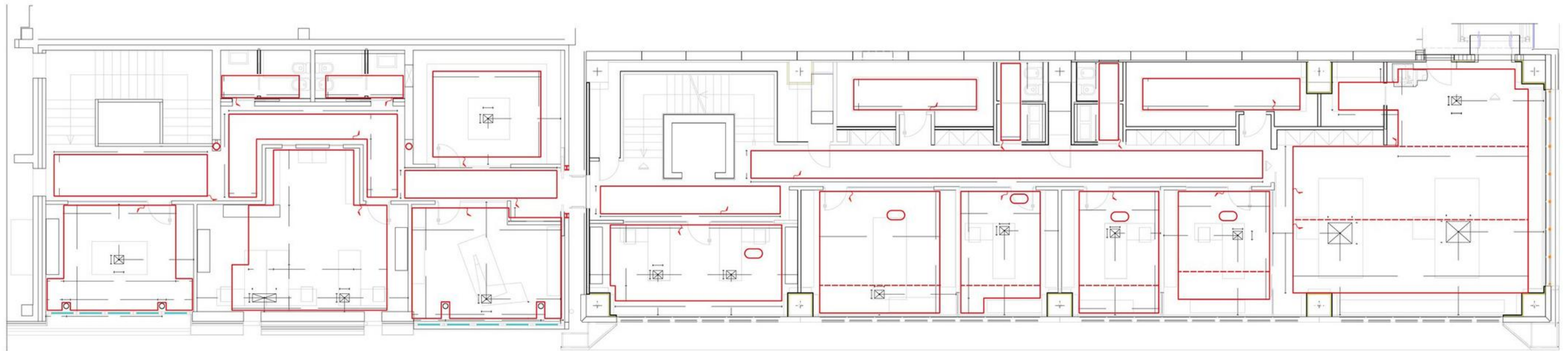

SOLUZIONI RADIANTI IN FIBRA DI CARBONIO

[www.lab44.it](http://www.lab44.it)



# PROGETTO

## PIANO SECONDO

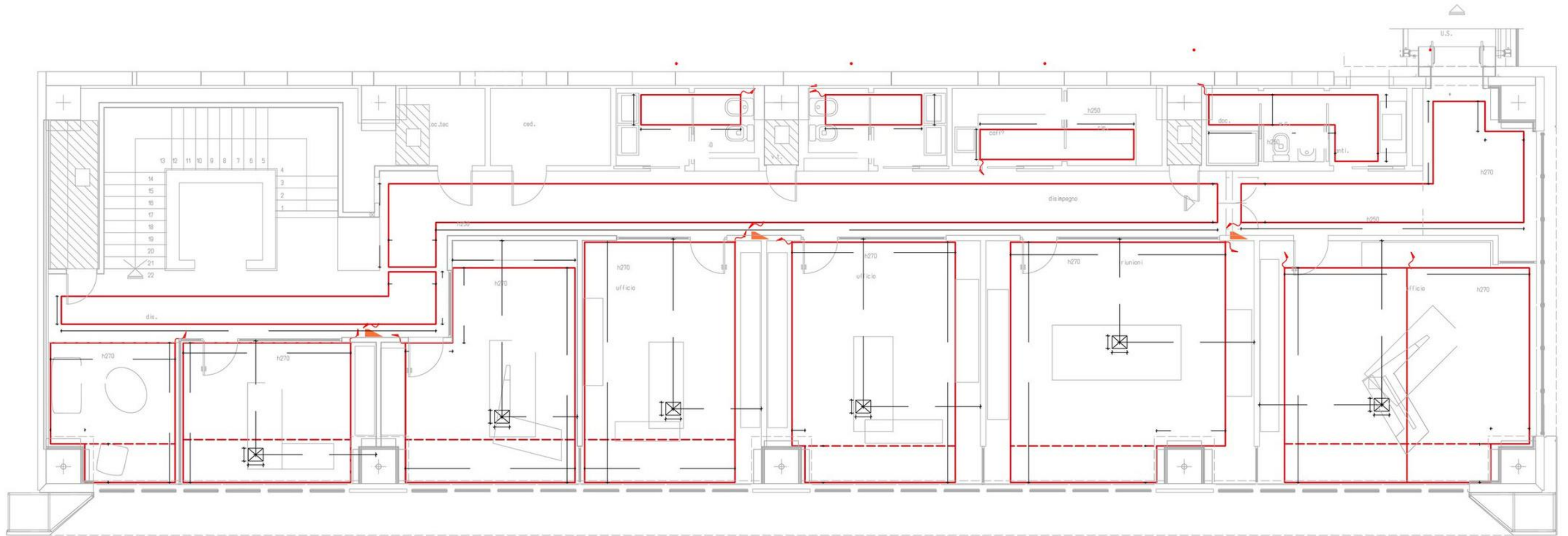

SOLUZIONI RADIANTI IN FIBRA DI CARBONIO

[www.lab44.it](http://www.lab44.it)



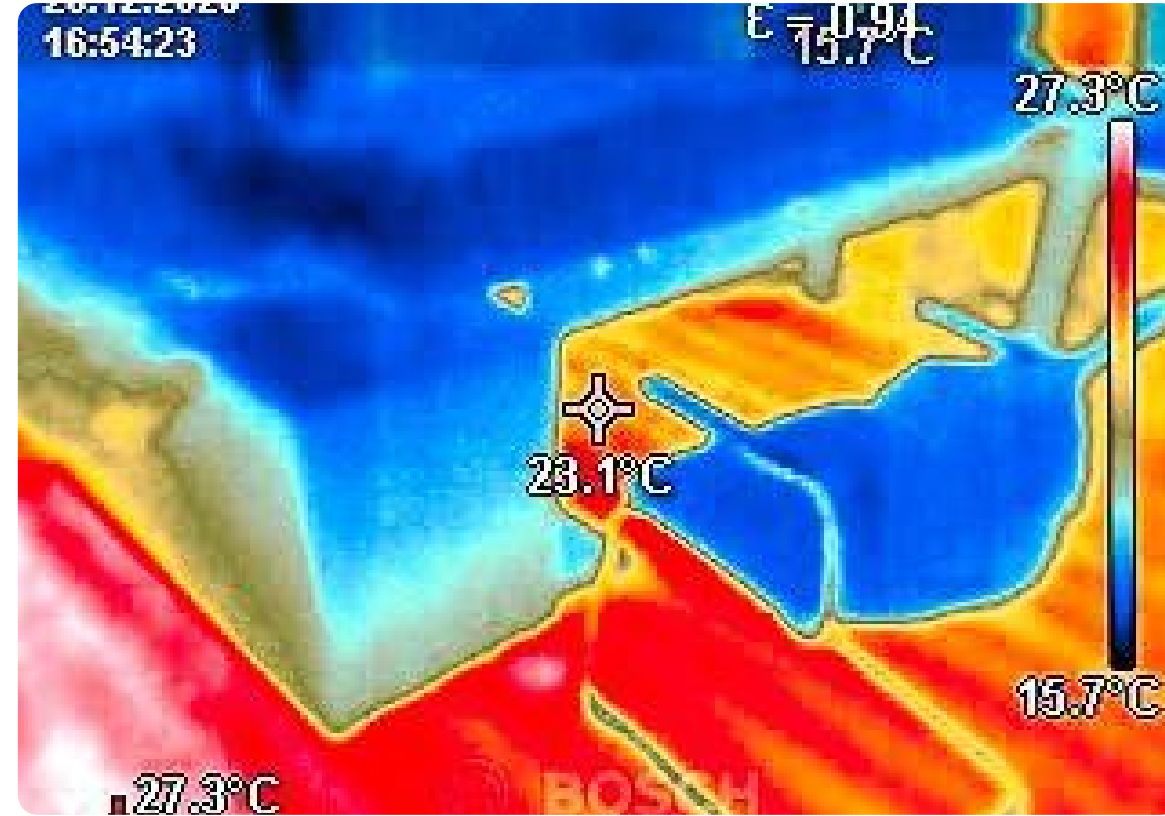

SOLUZIONI RADIANTI IN FIBRA DI CARBONIO

[www.lab44.it](http://www.lab44.it)



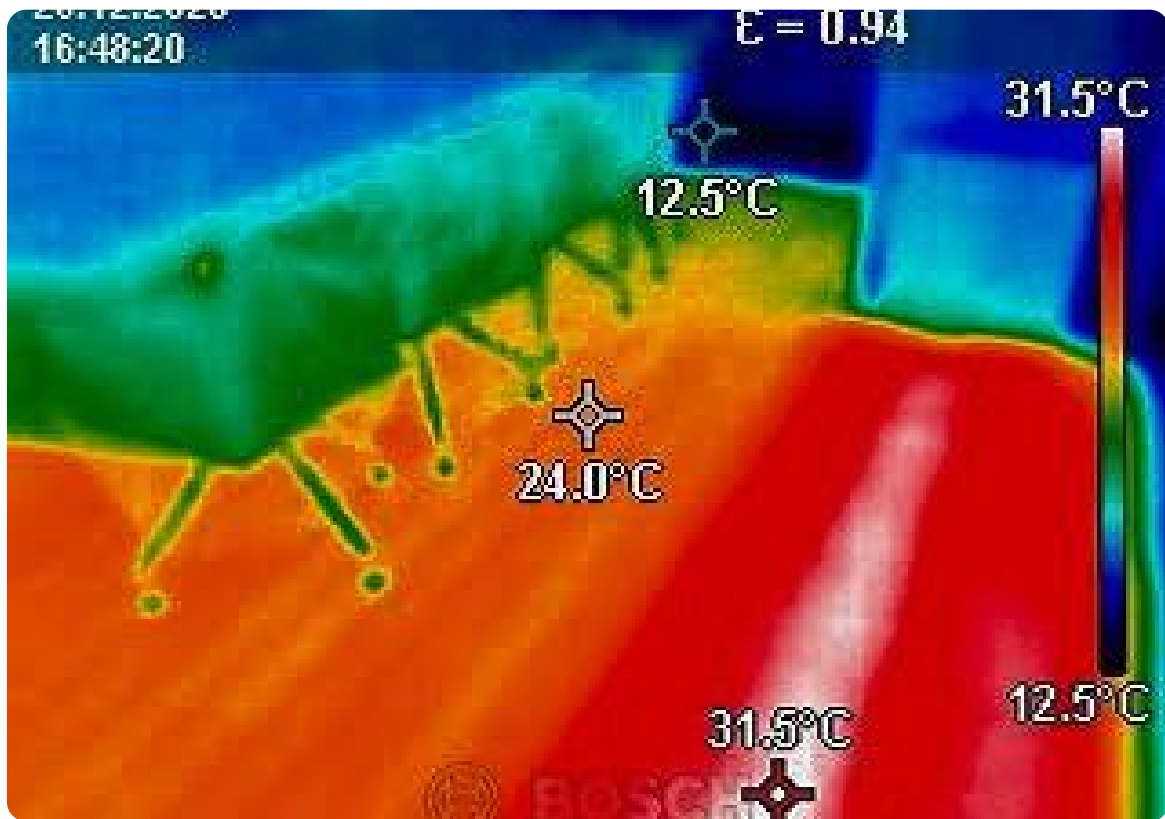

SOLUZIONI RADIANTI IN FIBRA DI CARBONIO

[www.lab44.it](http://www.lab44.it)





SOLUZIONI RADIANTI IN FIBRA DI CARBONIO

[www.lab44.it](http://www.lab44.it)



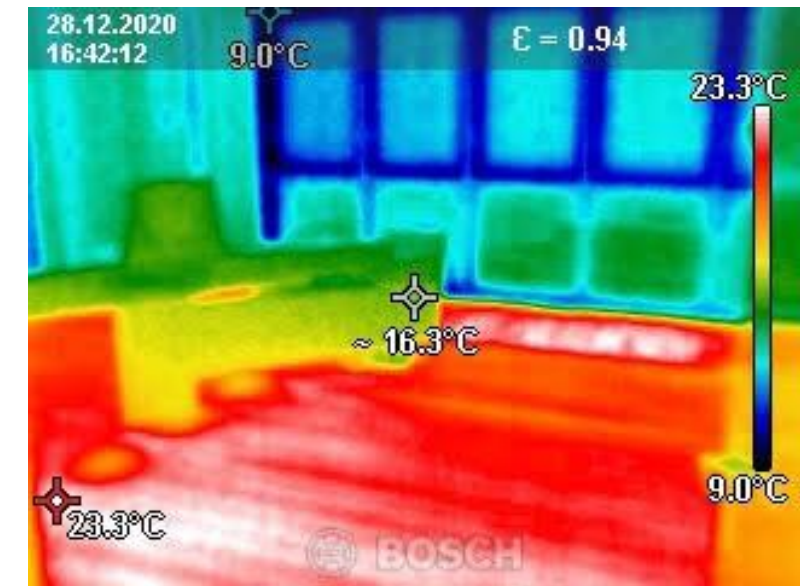
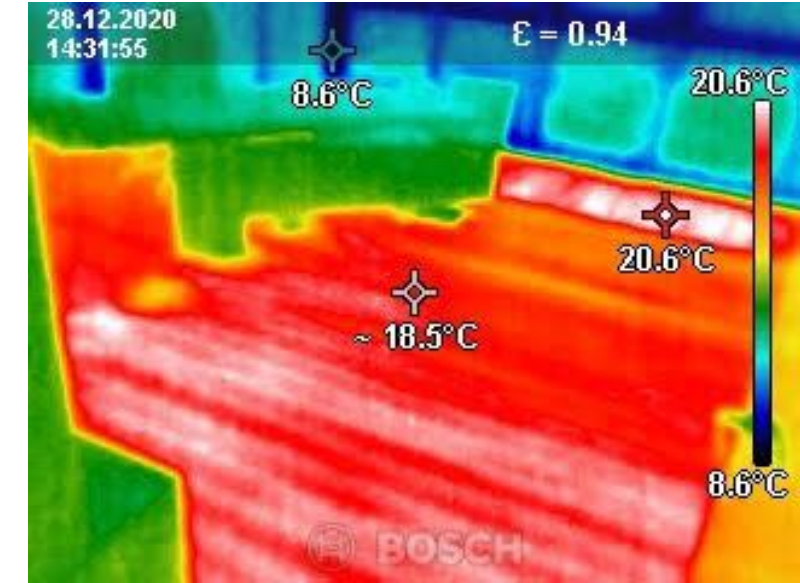

SOLUZIONI RADIANTI IN FIBRA DI CARBONIO

[www.lab44.it](http://www.lab44.it)





## CASE HISTORY

# RISCALDAMENTO SALA CORSI

**Realizzazione su misura**

**Committente:** O.M. P - Officine  
Mazzocco Pagnoni

**Località:** Argelato - Bologna



# PROGETTO

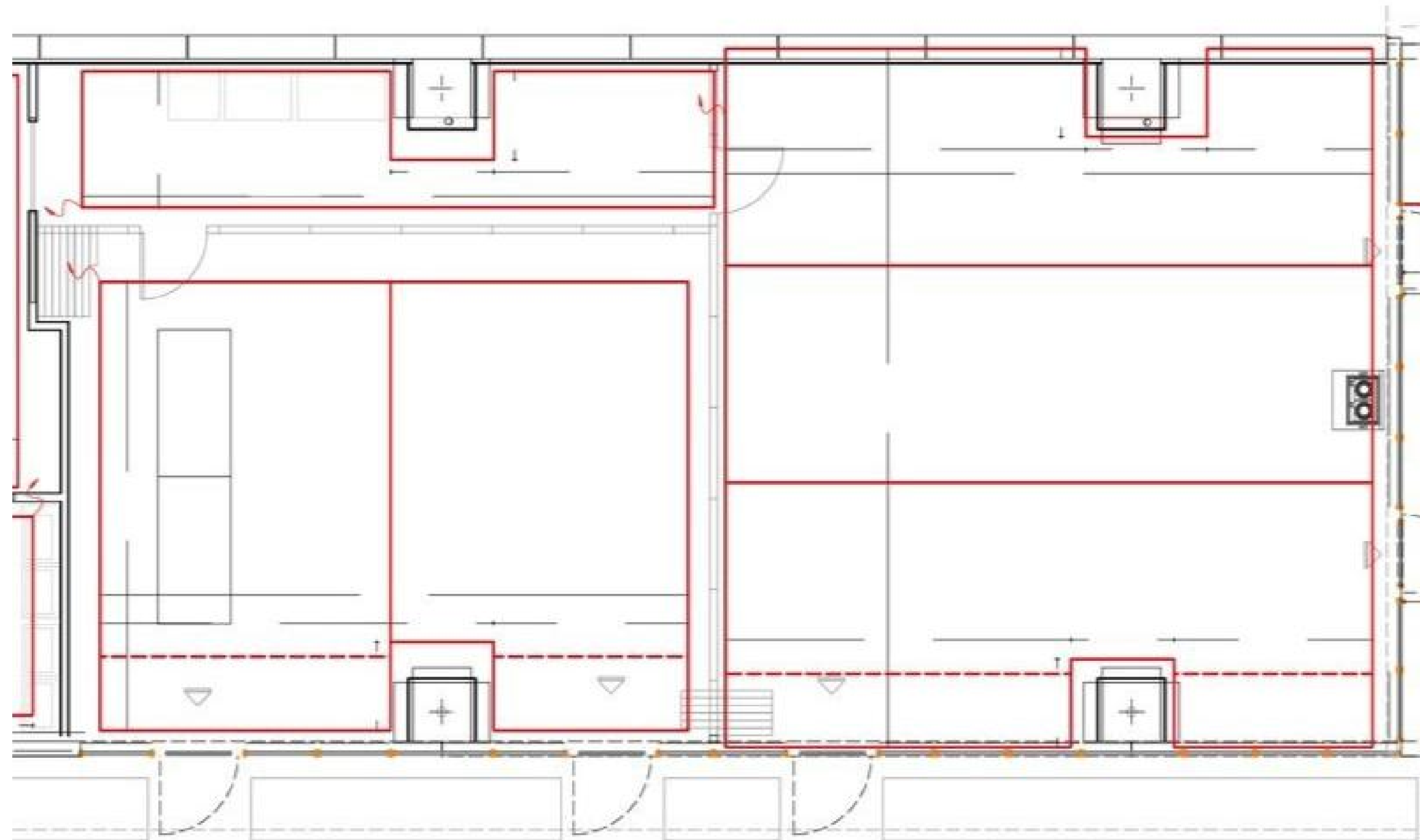

SOLUZIONI RADIANTI IN FIBRA DI CARBONIO

[www.lab44.it](http://www.lab44.it)





SOLUZIONI RADIANTI IN FIBRA DI CARBONIO

[www.lab44.it](http://www.lab44.it)



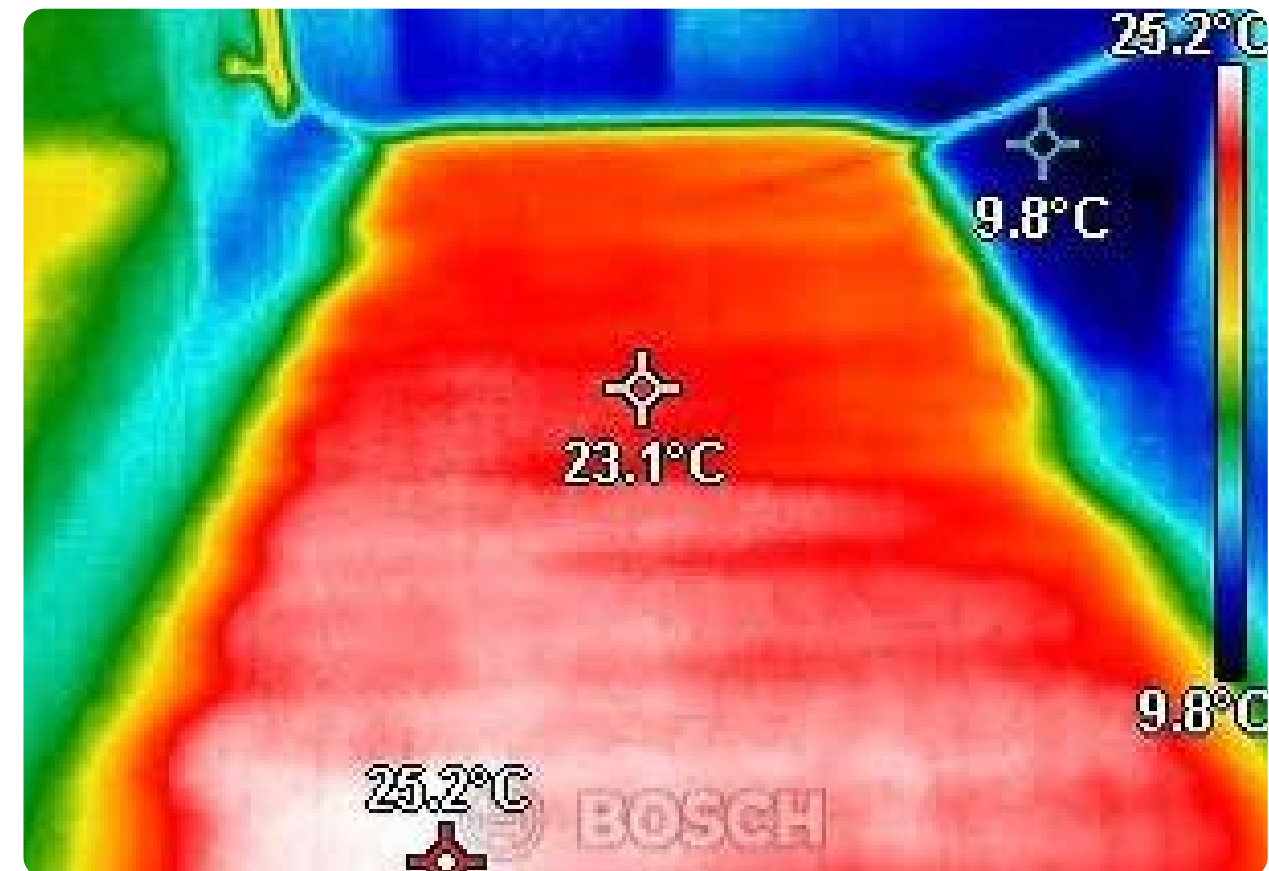
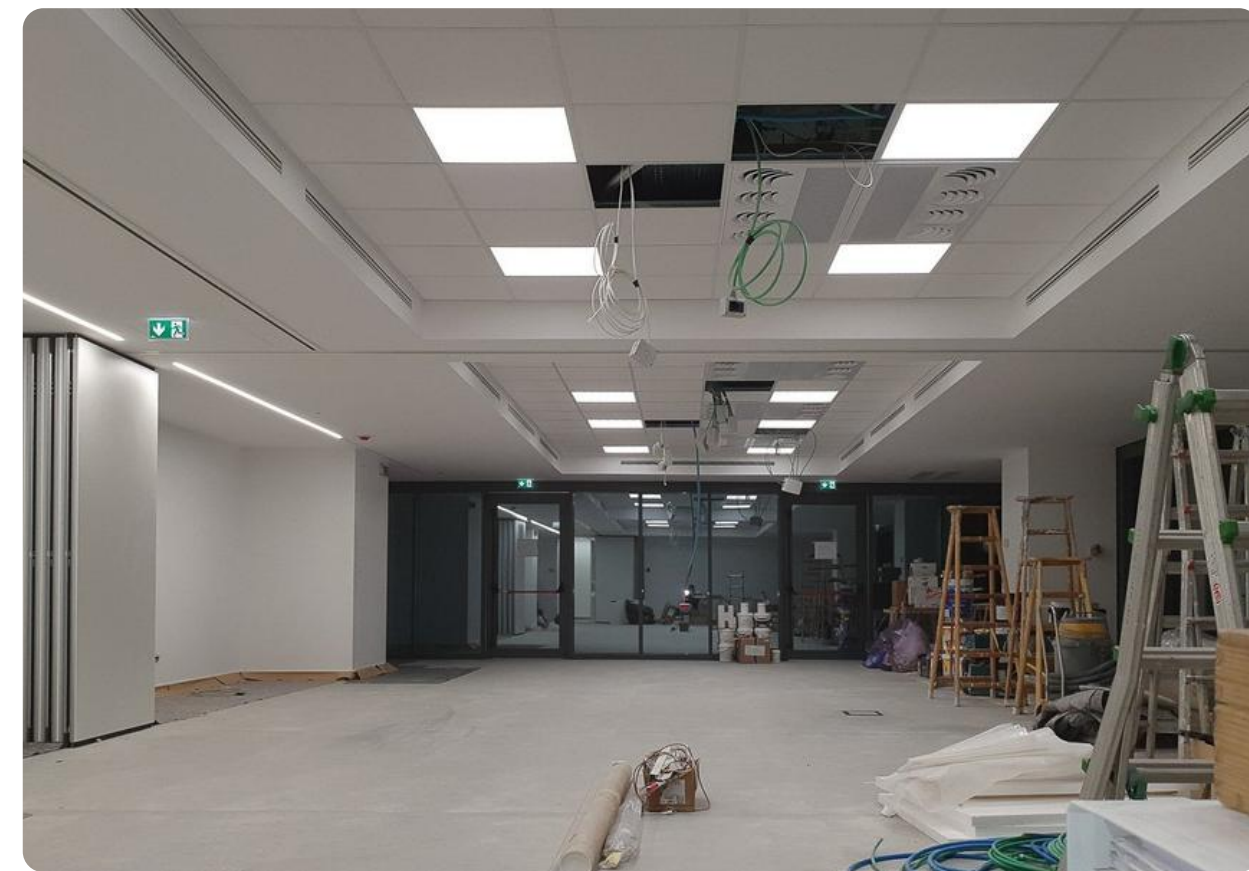

SOLUZIONI RADIANTI IN FIBRA DI CARBONIO

[www.lab44.it](http://www.lab44.it)





## CASE HISTORY

# RISCALDAMENTO RECEPTION

**Realizzazione su misura**

**Committente:** O.M. P - Officine  
Mazzocco Pagnoni

**Località:** Argelato - Bologna



SOLUZIONI RADIANTI IN FIBRA DI CARBONIO

[www.lab44.it](http://www.lab44.it)



# PROGETTO



SOLUZIONI RADIANTI IN FIBRA DI CARBONIO

[www.lab44.it](http://www.lab44.it)



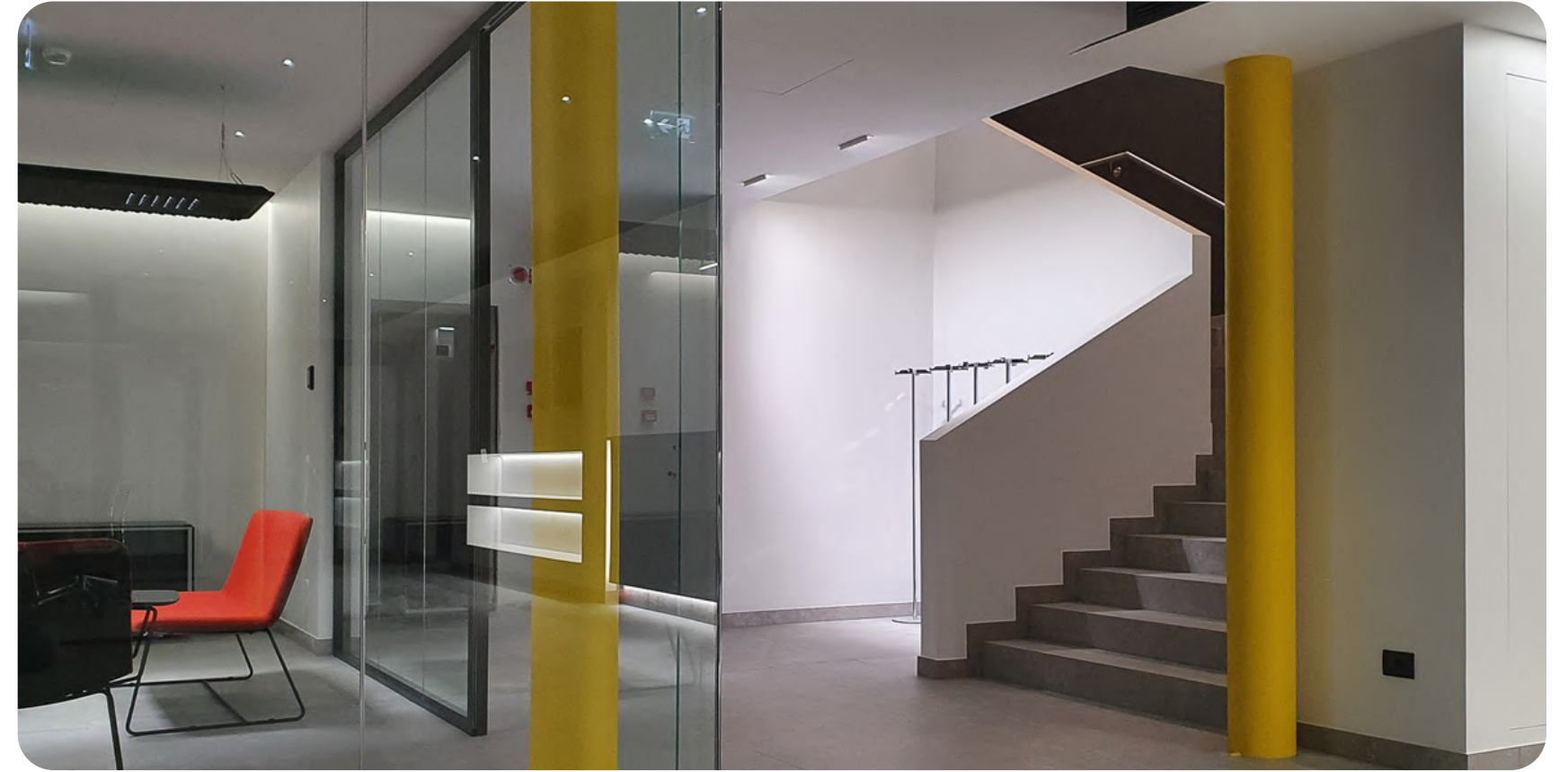

SOLUZIONI RADIANTI IN FIBRA DI CARBONIO

[www.lab44.it](http://www.lab44.it)



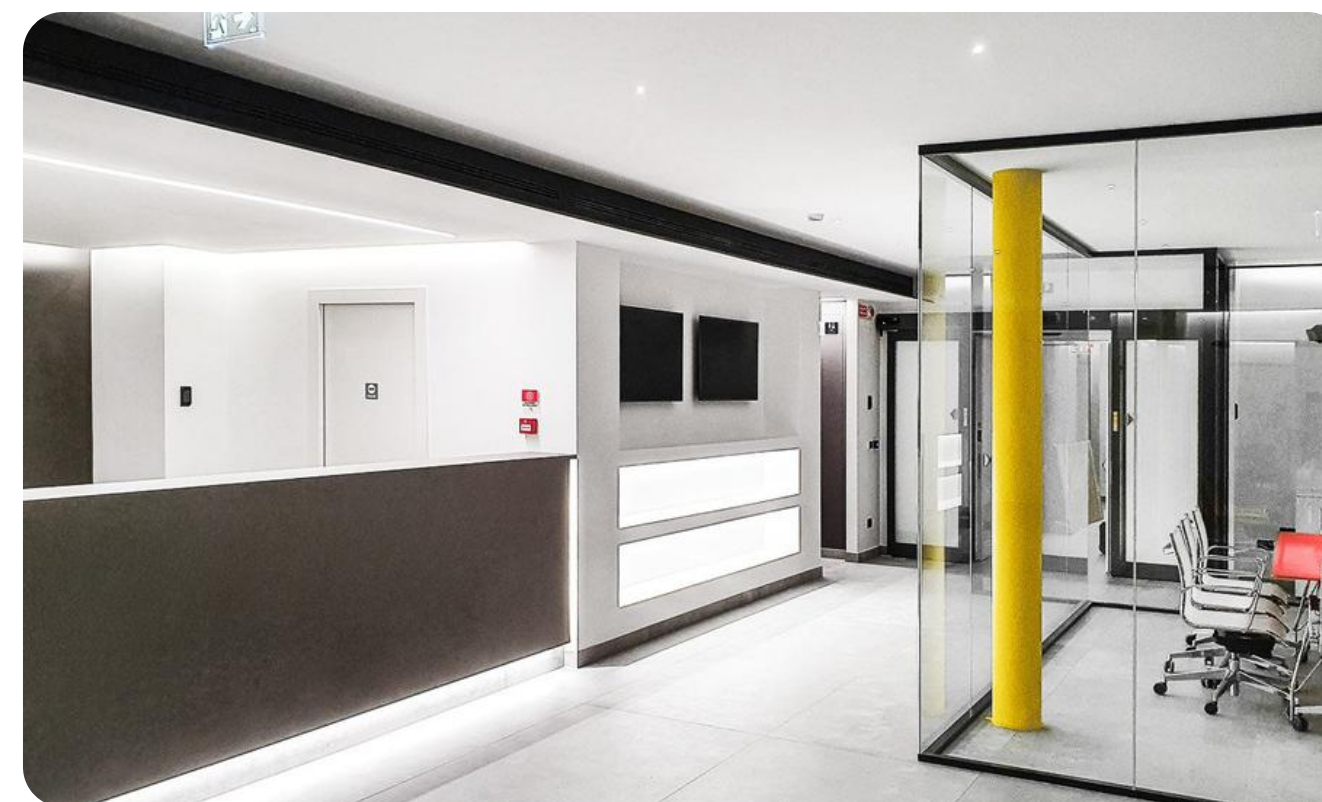
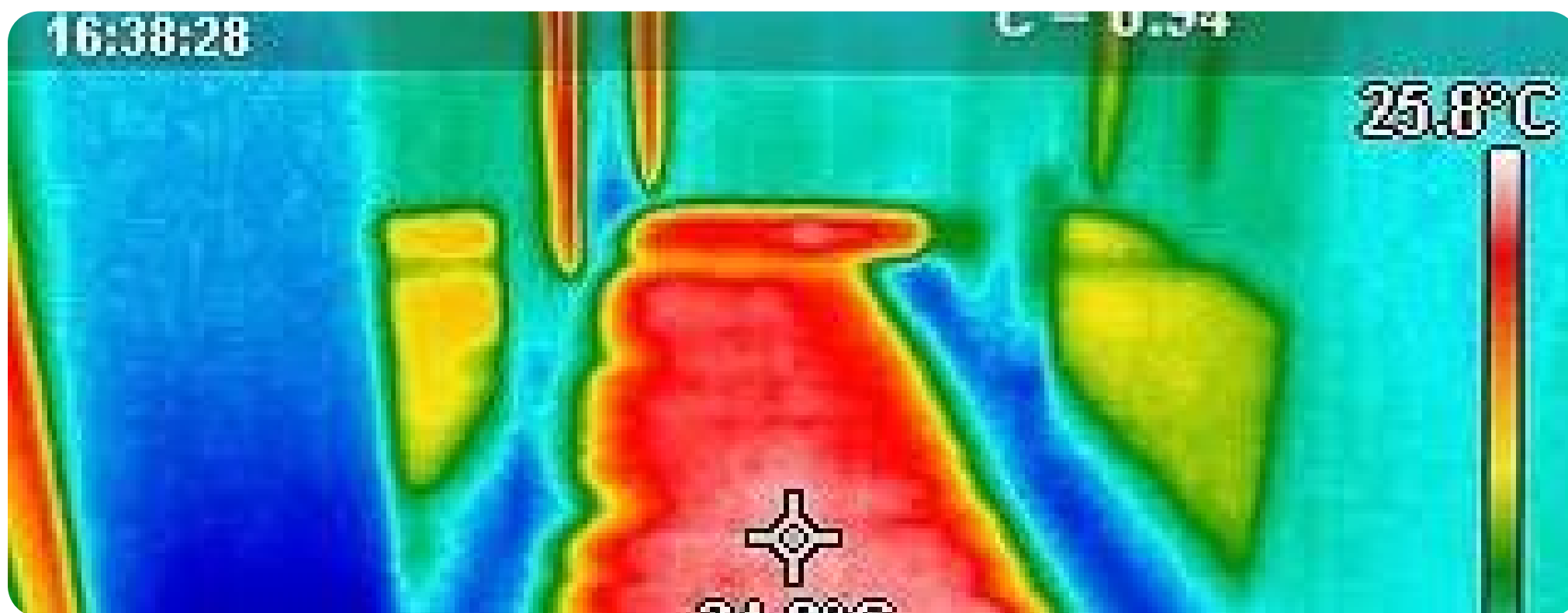
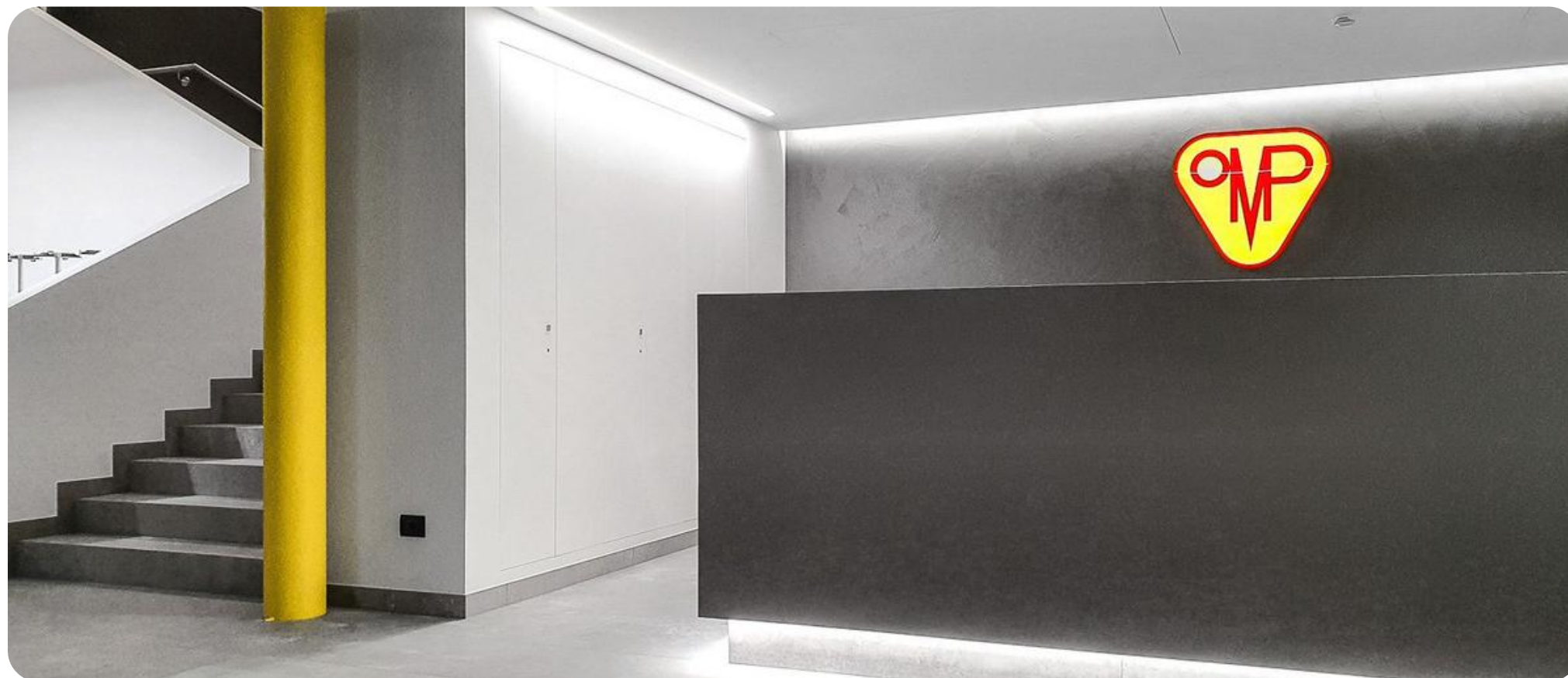

SOLUZIONI RADIANTI IN FIBRA DI CARBONIO

[www.lab44.it](http://www.lab44.it)



## CASE HISTORY

# RISCALDAMENTO AMPLIAMENTO RESIDENZIALE

Realizzazione su misura

Località: Barbato Vittorio

Località: vigonza

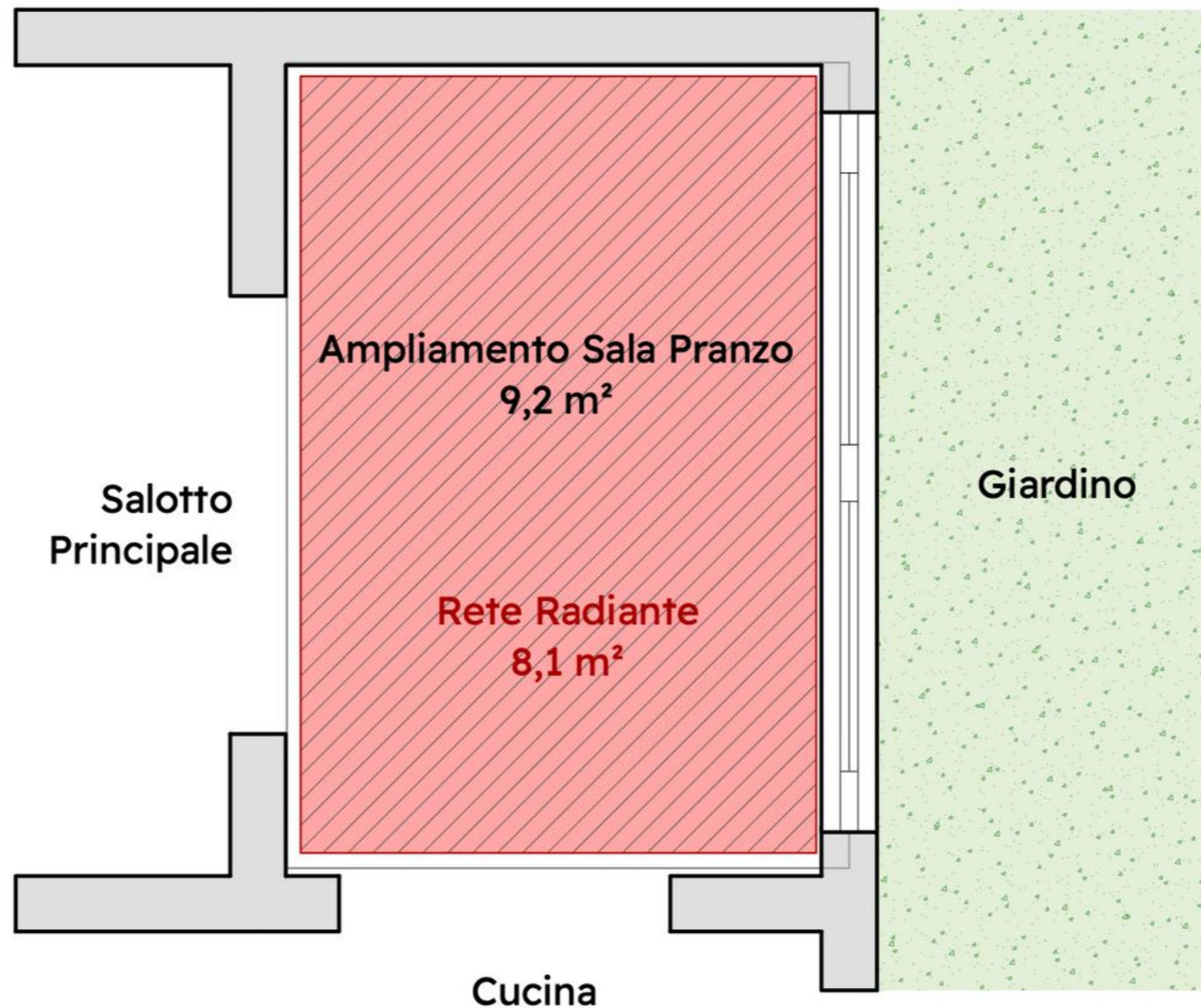





SOLUZIONI RADIANTI IN FIBRA DI CARBONIO

[www.lab44.it](http://www.lab44.it)





SOLUZIONI RADIANTI IN FIBRA DI CARBONIO

[www.lab44.it](http://www.lab44.it)





## CASE HISTORY

# SEDUTE RADIANTI DA ESTERNO

**Realizzazione su misura**

**Committente:** Scuderia "I Cedri"  
A.S.D.

**Località:** Sala Baganza - Parma

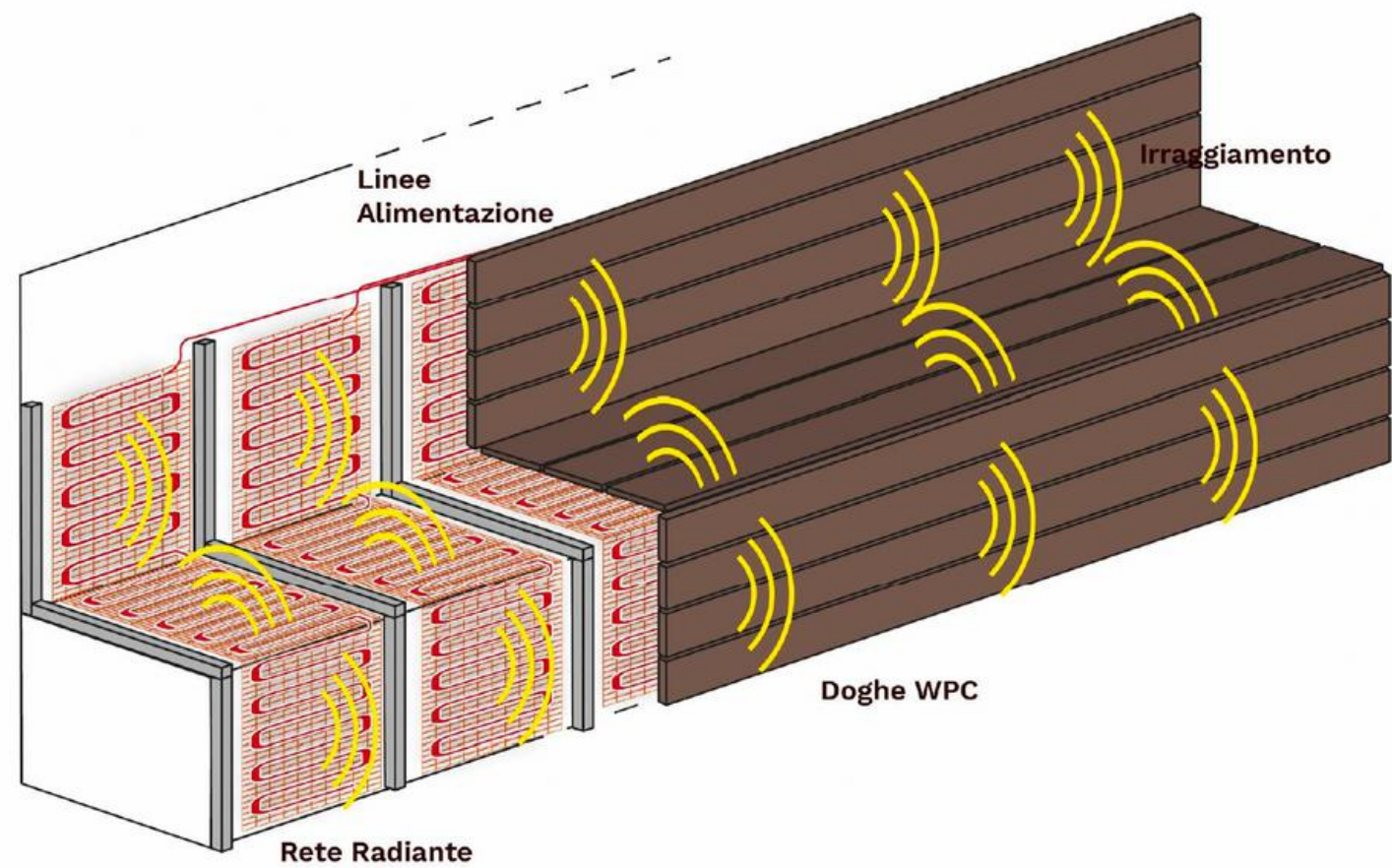

SOLUZIONI RADIANTI IN FIBRA DI CARBONIO

[www.lab44.it](http://www.lab44.it)



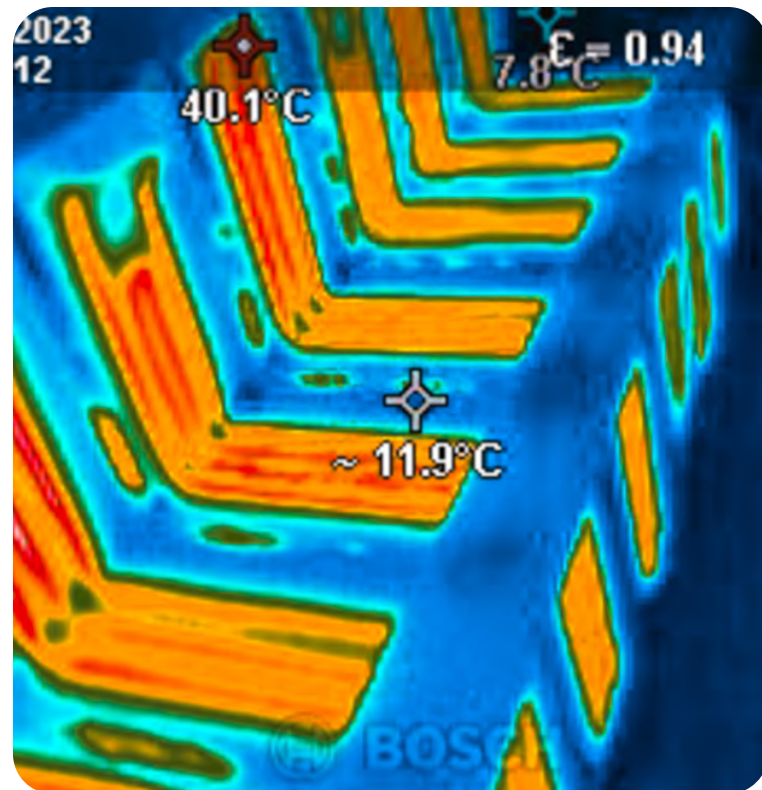
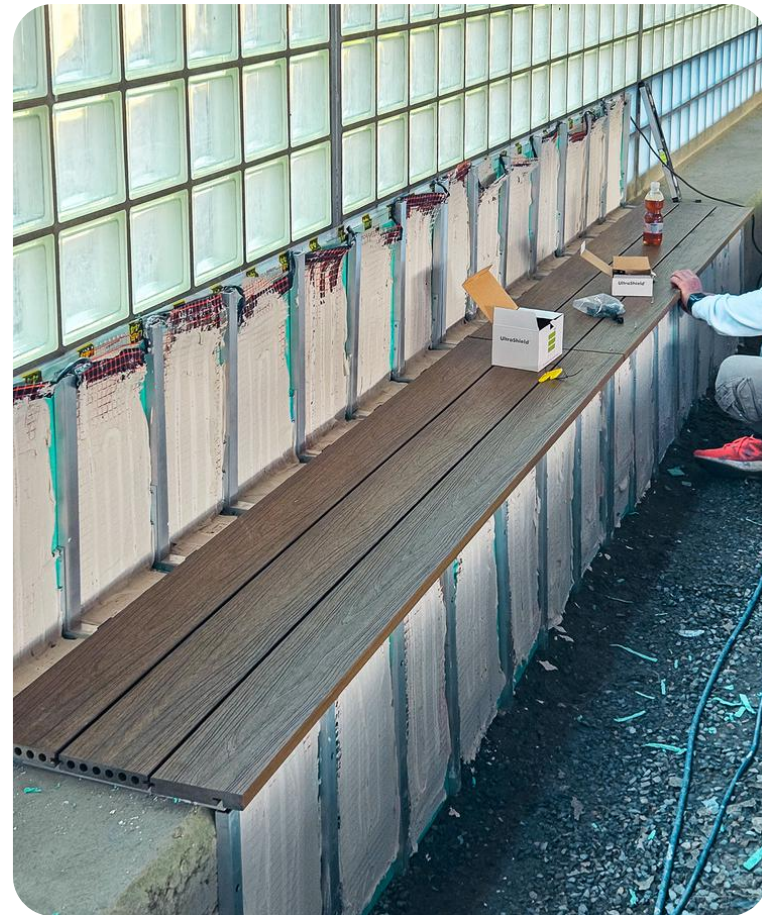

SOLUZIONI RADIANTI IN FIBRA DI CARBONIO

[www.lab44.it](http://www.lab44.it)



# PRODOTTI RADIANTI

## INTEGRAZIONE RISCALDAMENTO A PARETE PER INTERNI



Integrano il calore degli interni con una sensazione di benessere e confortevole

# RETE RADIANTE SOTTO INTONACO

## **SPESSORE MINIMO**

Ideale per applicazione sotto uno strato di intonaco

## **MURATURA TRADIZIONALE**

Pareti in muratura radianti

SOLUZIONI RADIANTI IN FIBRA DI CARBONIO



[www.lab44.it](http://www.lab44.it)





## CASE HISTORY

# RISCALDAMENTO INTERNO DOCCIA

Realizzazione su misura

Località: Venezia

SOLUZIONI RADIANTI IN FIBRA DI CARBONIO

[www.lab44.it](http://www.lab44.it)





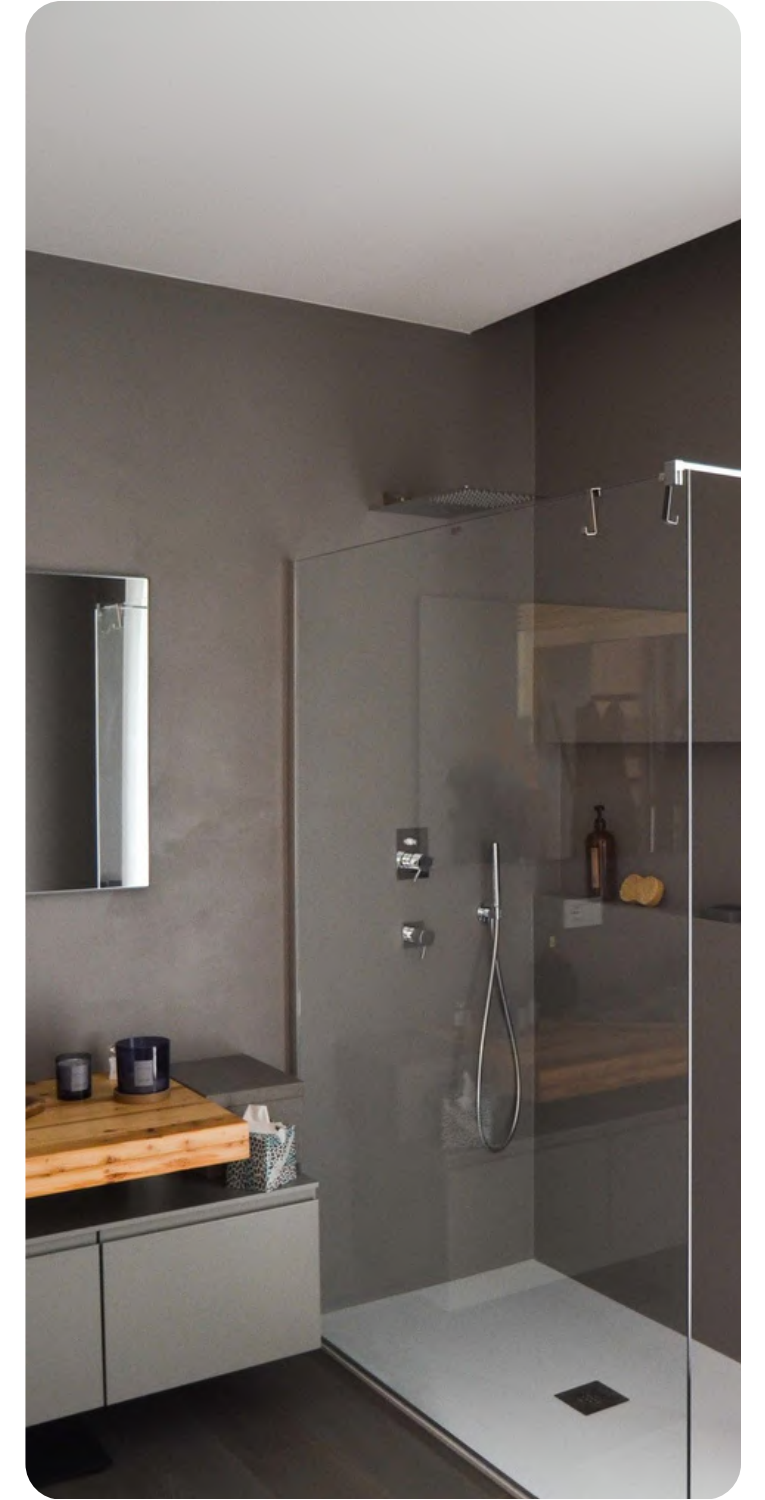

SOLUZIONI RADIANTI IN FIBRA DI CARBONIO

[www.lab44.it](http://www.lab44.it)



# TERMOPANNELLO RETRO CARTONGESSO

## FACILE E MODULARE

Si incolla sul retro della lastra in cartongesso

## PER PARETI E SOFFITTI

## ANCHE PER INTERNO DOCCIA

Con alimentazione dedicata 24V

SOLUZIONI RADIANTI IN FIBRA DI CARBONIO





## CASE HISTORY

# INTEGRAZIONE A PARETE “VILLA RINALDI”



Realizzazione su misura

Località: Asolo - Treviso

SOLUZIONI RADIANTI IN FIBRA DI CARBONIO

[www.lab44.it](http://www.lab44.it)





SOLUZIONI RADIANTI IN FIBRA DI CARBONIO

[www.lab44.it](http://www.lab44.it)





SOLUZIONI RADIANTI IN FIBRA DI CARBONIO

[www.lab44.it](http://www.lab44.it)





## CASE HISTORY

# INTEGRAZIONE A PARETE BAGNI

**Realizzazione su misura**

**Committente:** O.M. P - Officine  
Mazzocco Pagnoni

**Località:** Argelato - Bologna

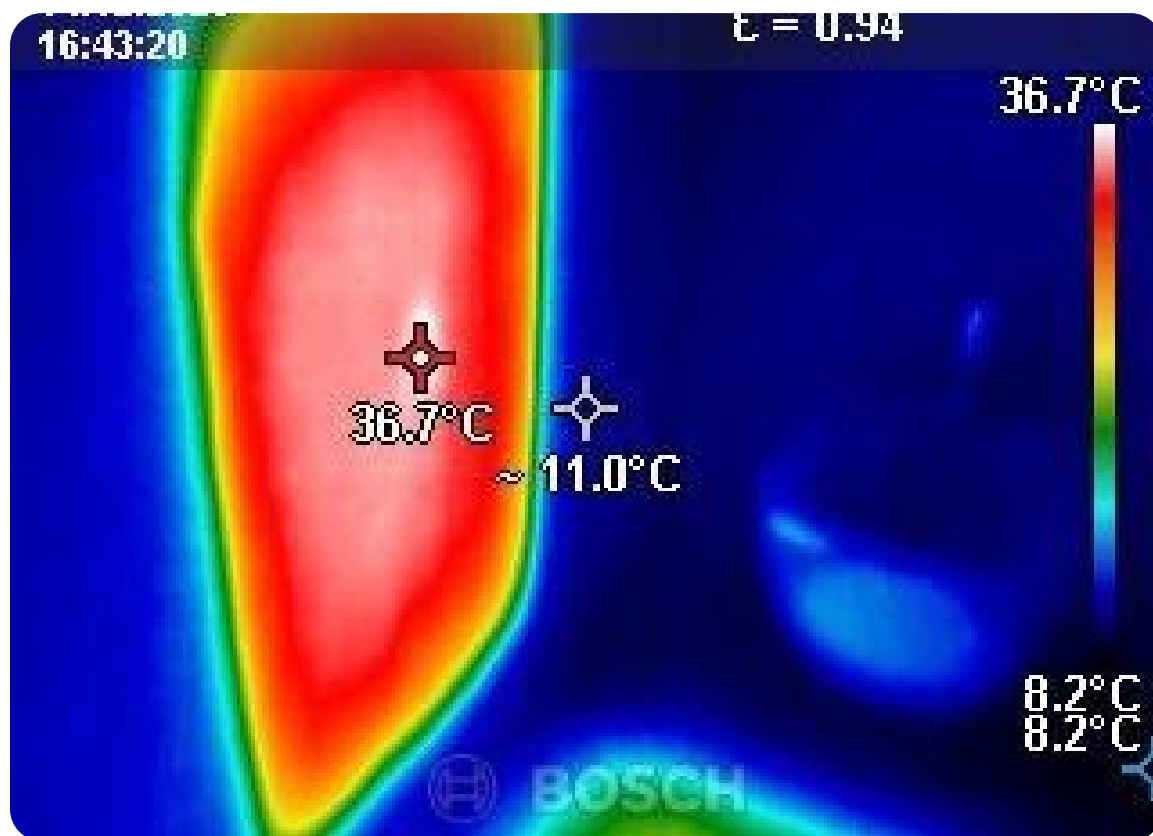

SOLUZIONI RADIANTI IN FIBRA DI CARBONIO

[www.lab44.it](http://www.lab44.it)



# PROGETTO

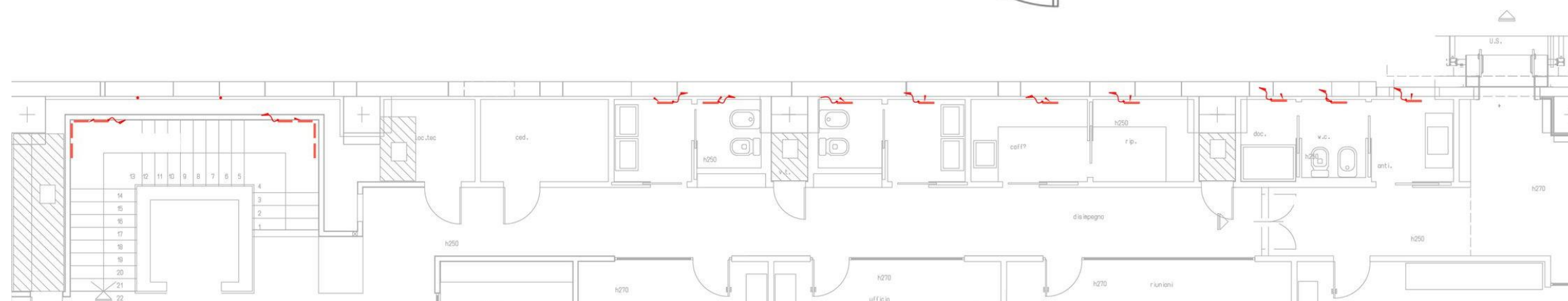
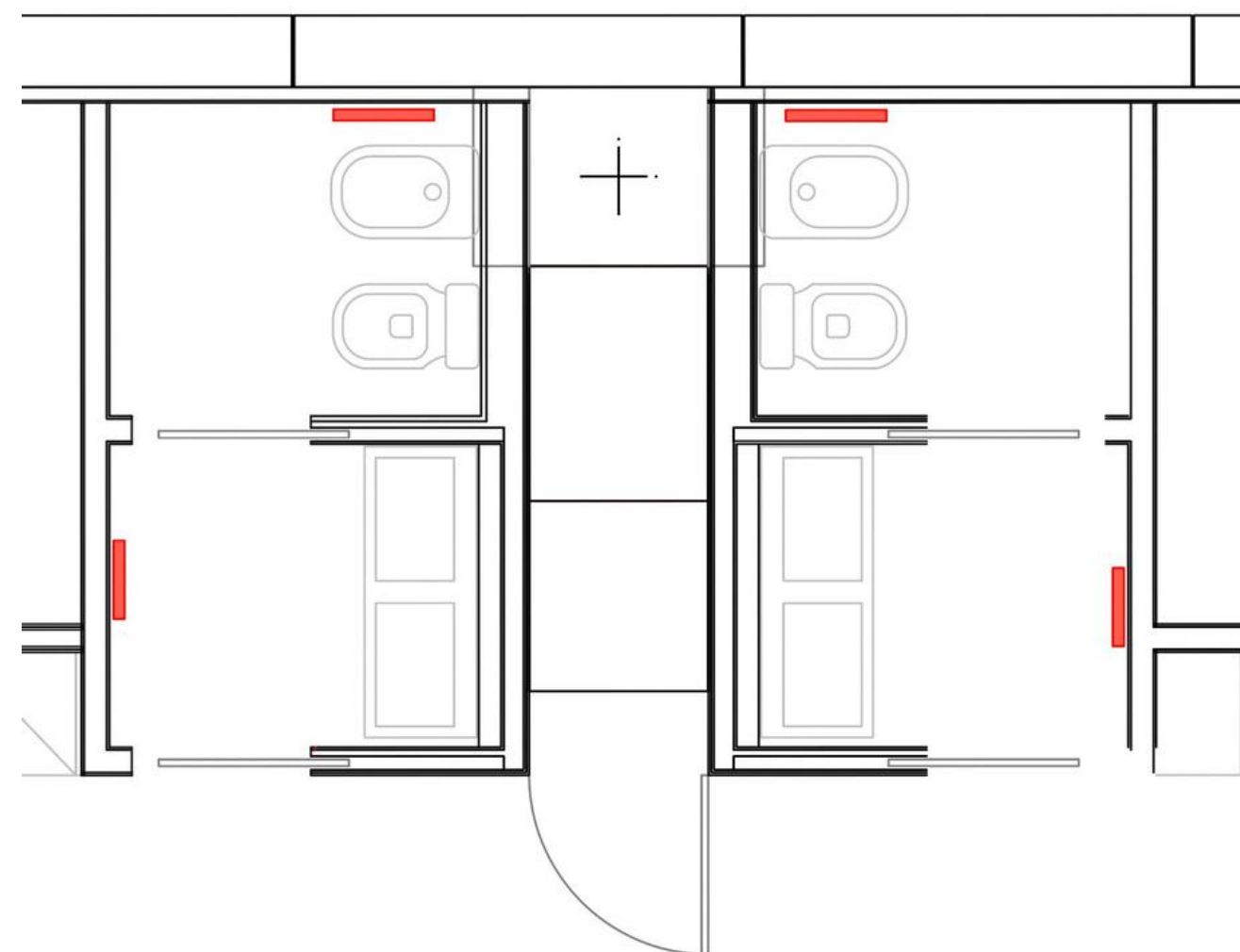
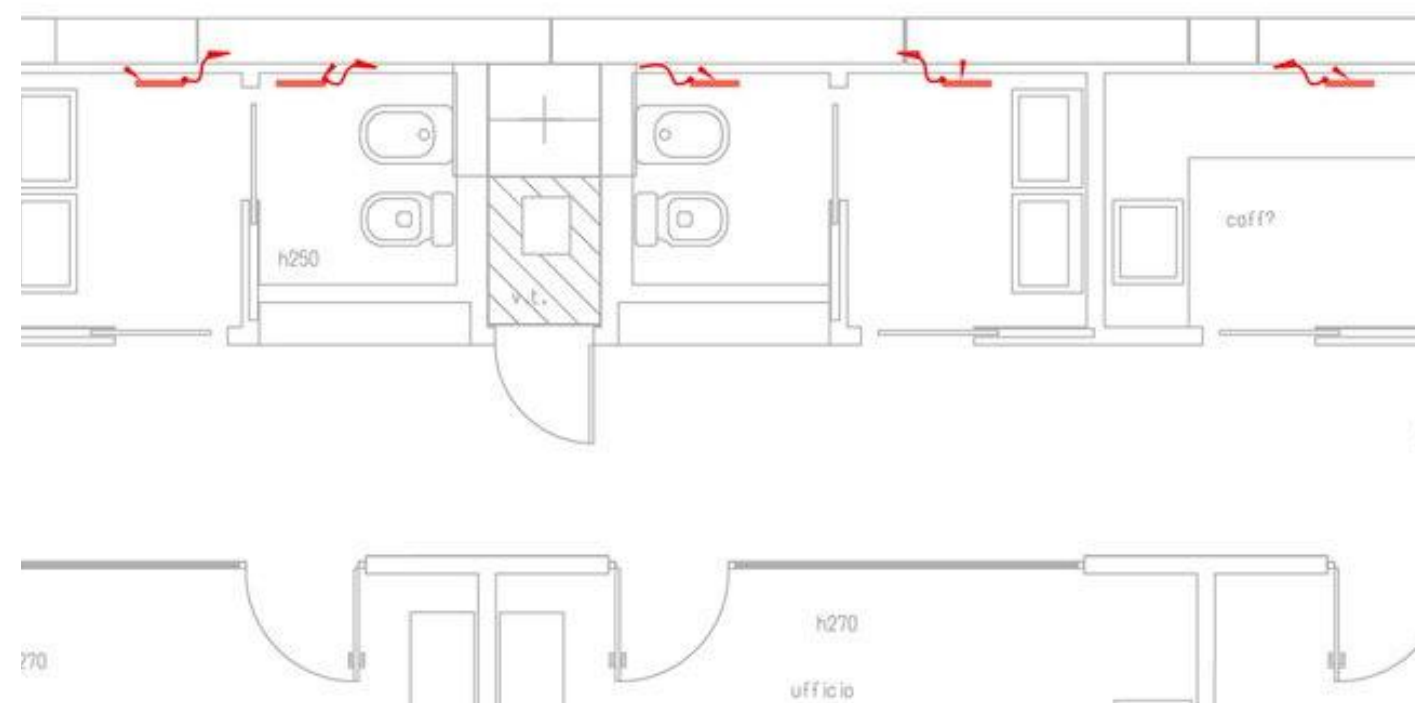

SOLUZIONI RADIANTI IN FIBRA DI CARBONIO

[www.lab44.it](http://www.lab44.it)



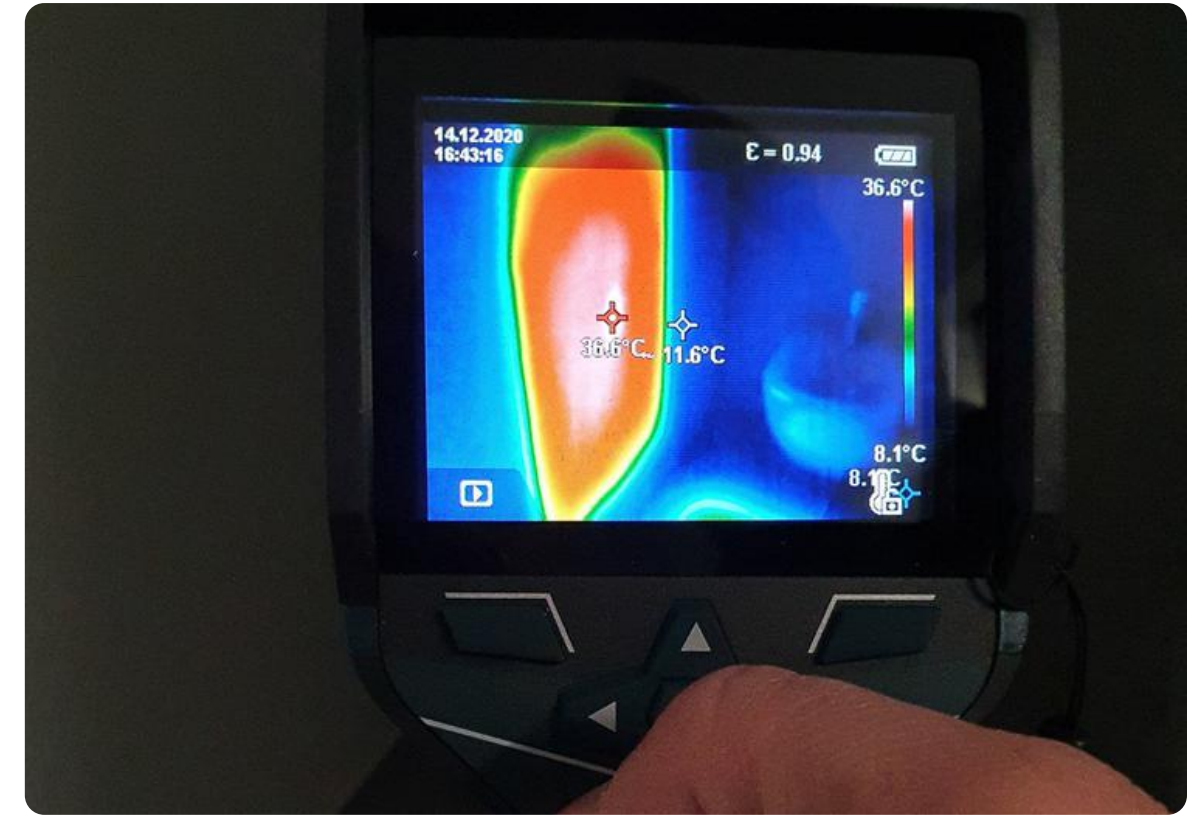
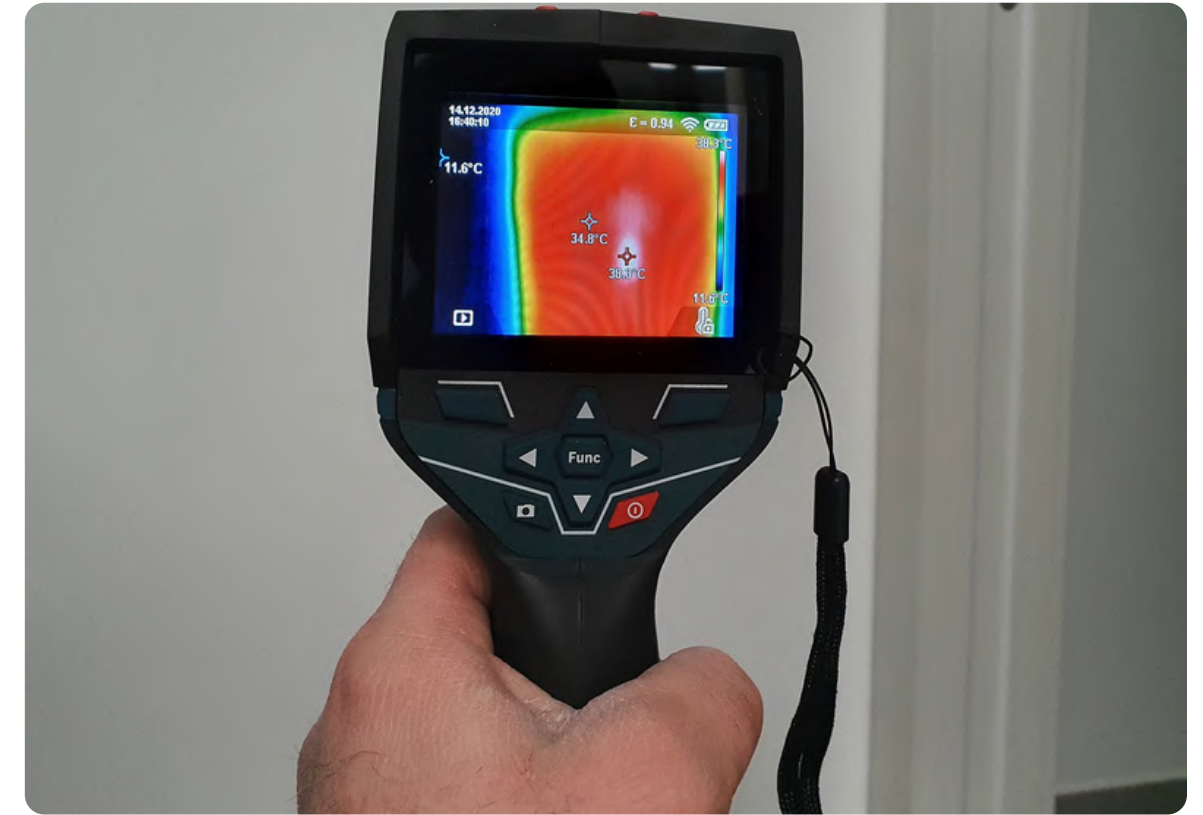

SOLUZIONI RADIANTI IN FIBRA DI CARBONIO

[www.lab44.it](http://www.lab44.it)







## CASE HISTORY

# INTEGRAZIONE A PARETE VANO SCALE

**Realizzazione su misura**

**Committente:** O.M. P - Officine  
Mazzocco Pagnoni

**Località:** Argelato - Bologna

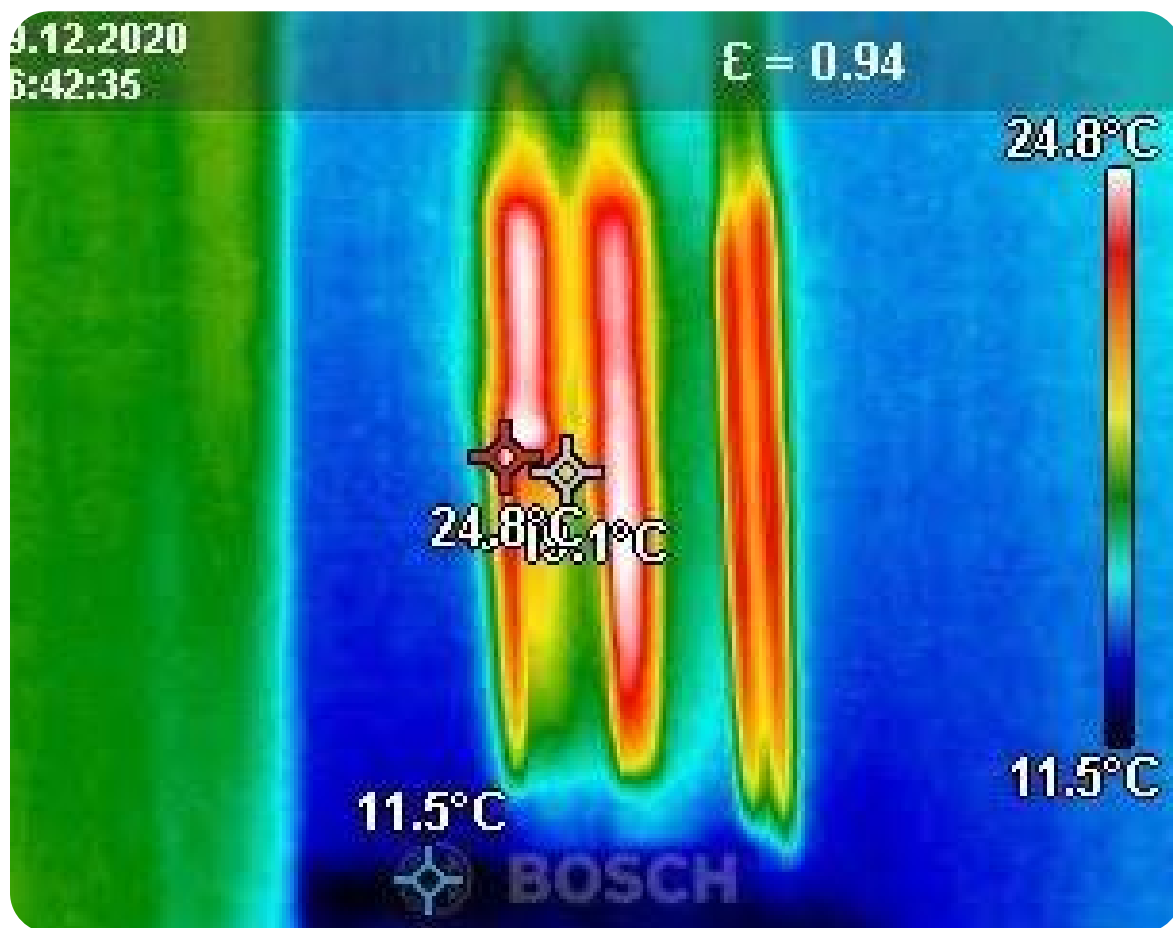

SOLUZIONI RADIANTI IN FIBRA DI CARBONIO

[www.lab44.it](http://www.lab44.it)



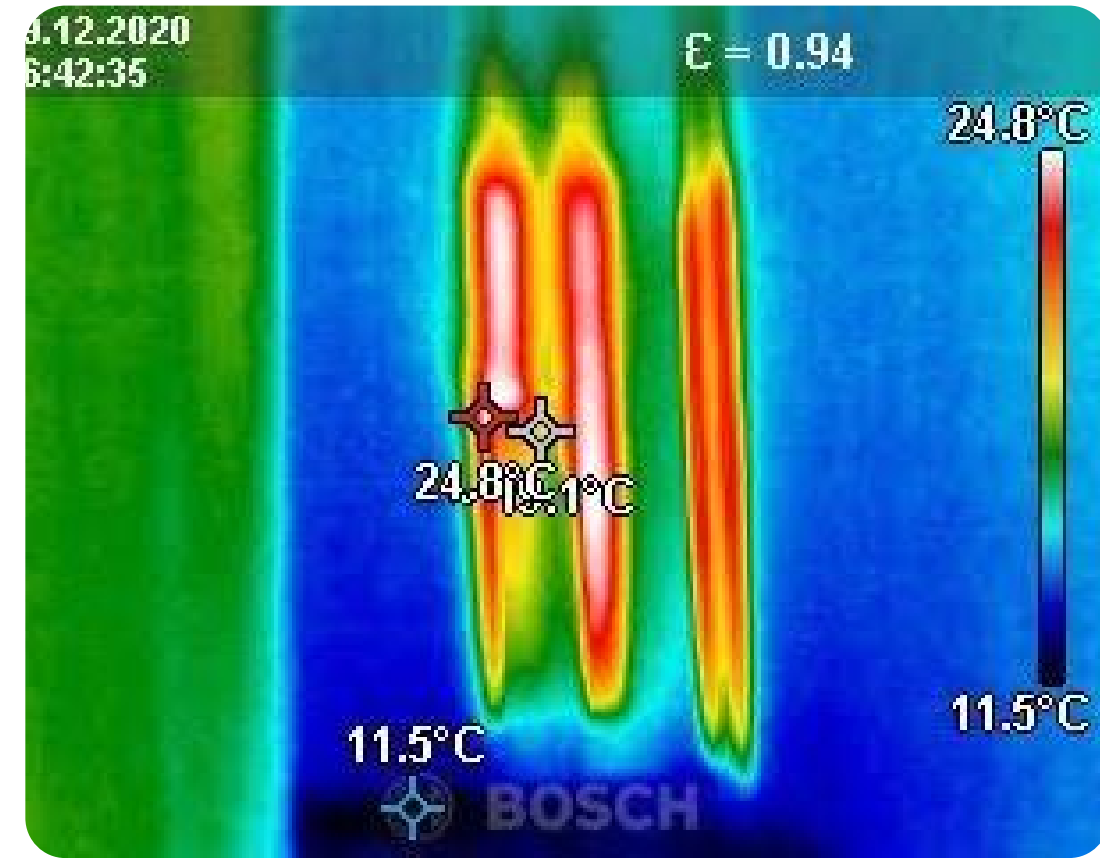

SOLUZIONI RADIANTI IN FIBRA DI CARBONIO

[www.lab44.it](http://www.lab44.it)





## CASE HISTORY

# INTEGRAZIONE A PARETE UFFICI

**Progettista:** Studio Locatelli Pepato

**Località:** Padova

SOLUZIONI RADIANTI IN FIBRA DI CARBONIO

[www.lab44.it](http://www.lab44.it)



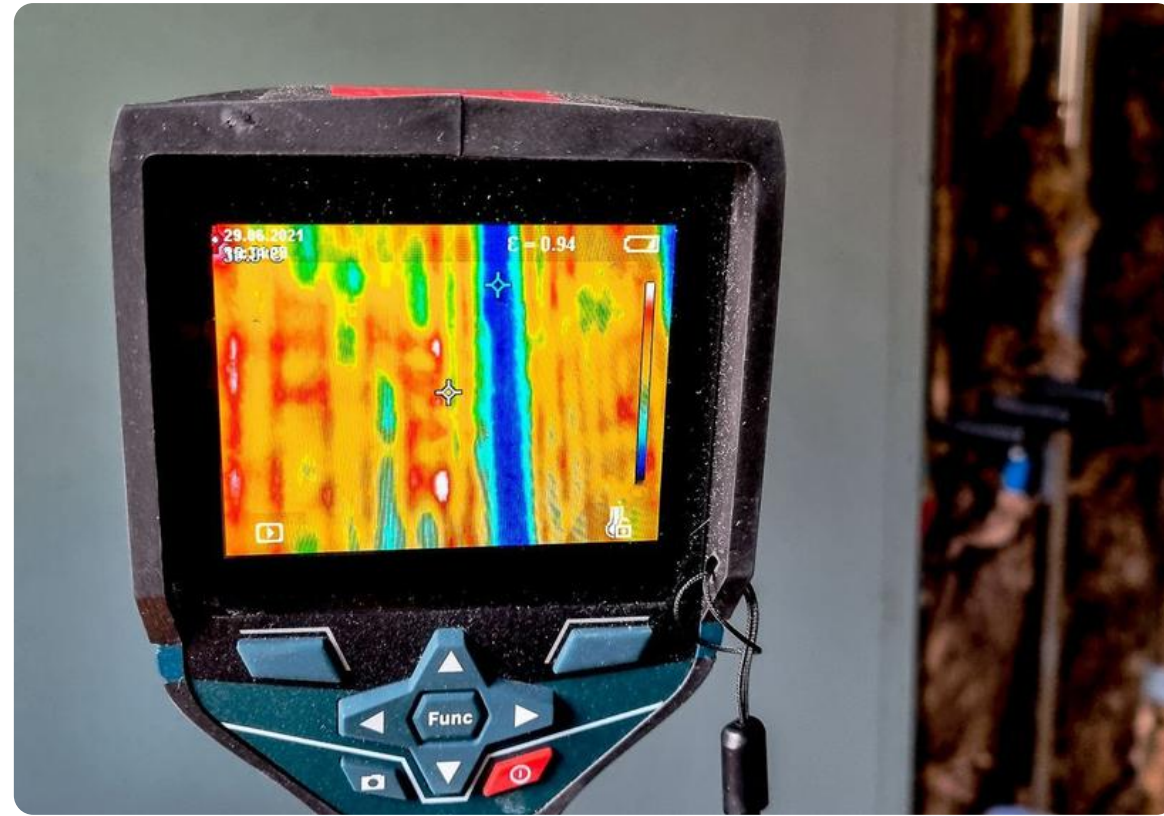

SOLUZIONI RADIANTI IN FIBRA DI CARBONIO

[www.lab44.it](http://www.lab44.it)





## CASE HISTORY

# INTEGRAZIONE A SOFFITTO RESIDENZIALE

**Progettista:** Studio Locatelli Pepato

**Località:** Padova



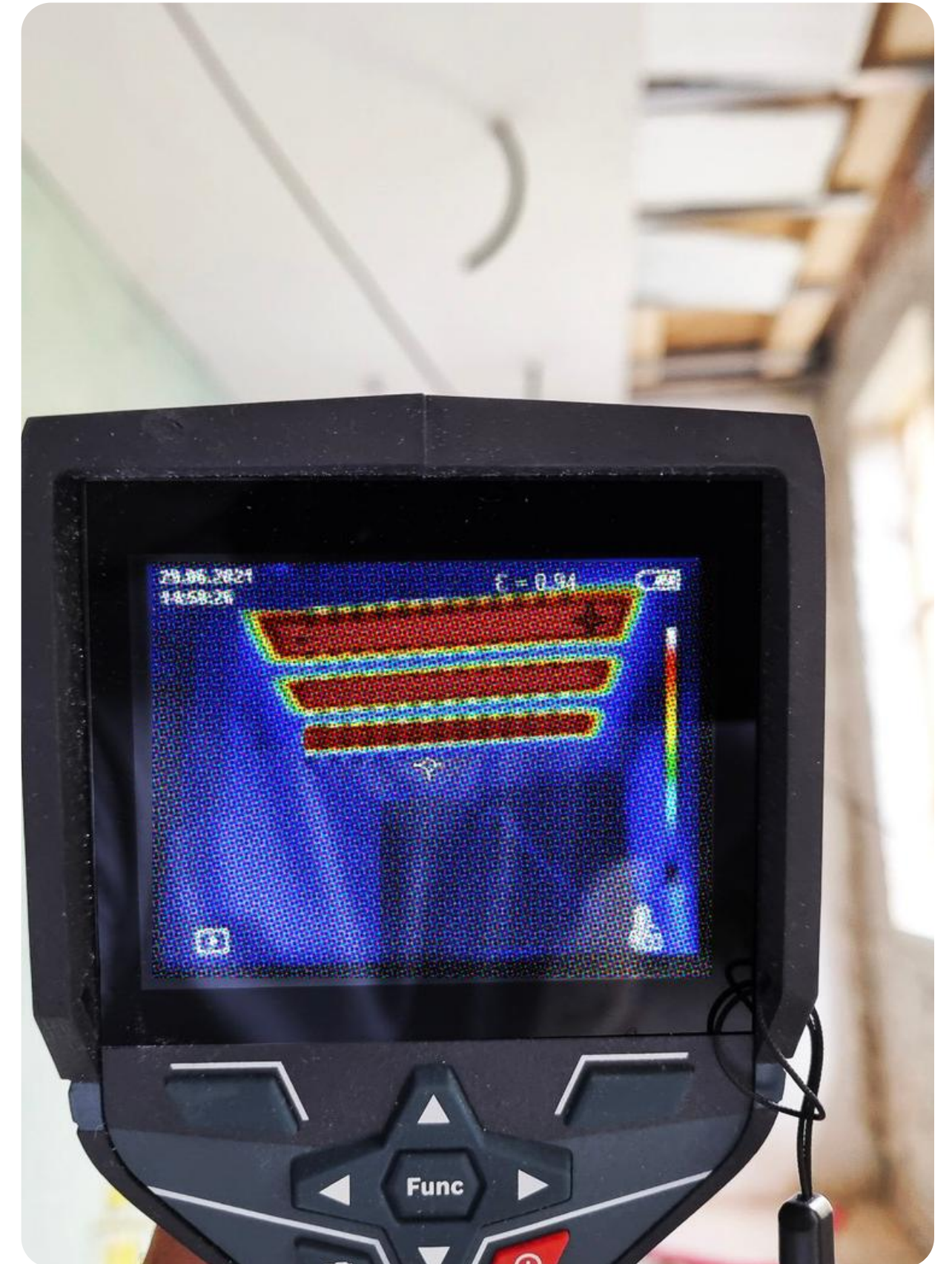

SOLUZIONI RADIANTI IN FIBRA DI CARBONIO

[www.lab44.it](http://www.lab44.it)



# PRODOTTI RADIANTI

## RETE ANTIUMIDITÀ

SOLUZIONE SOTTO INTONACO PER CONTRASTARE  
GLI EFFETTI DELL'UMIDITÀ DI RISALITA



Asciuga le particelle d'acqua presenti nella muratura  
mantenendo gli edifici salubri

# RETE ANTIUMIDITÀ SOTTO INTONACO

## **INSTALLAZIONE**

Sotto intonaco alla base del perimetro delle pareti interessate dal fenomeno

## **AMBIENTI PIÙ SALUBRI**

Previene la formazione di muffe e la diffusione batterica

## **MURATURA INTATTA**

Previene rigonfiamenti e danneggiamenti all'intonaco e alla muratura

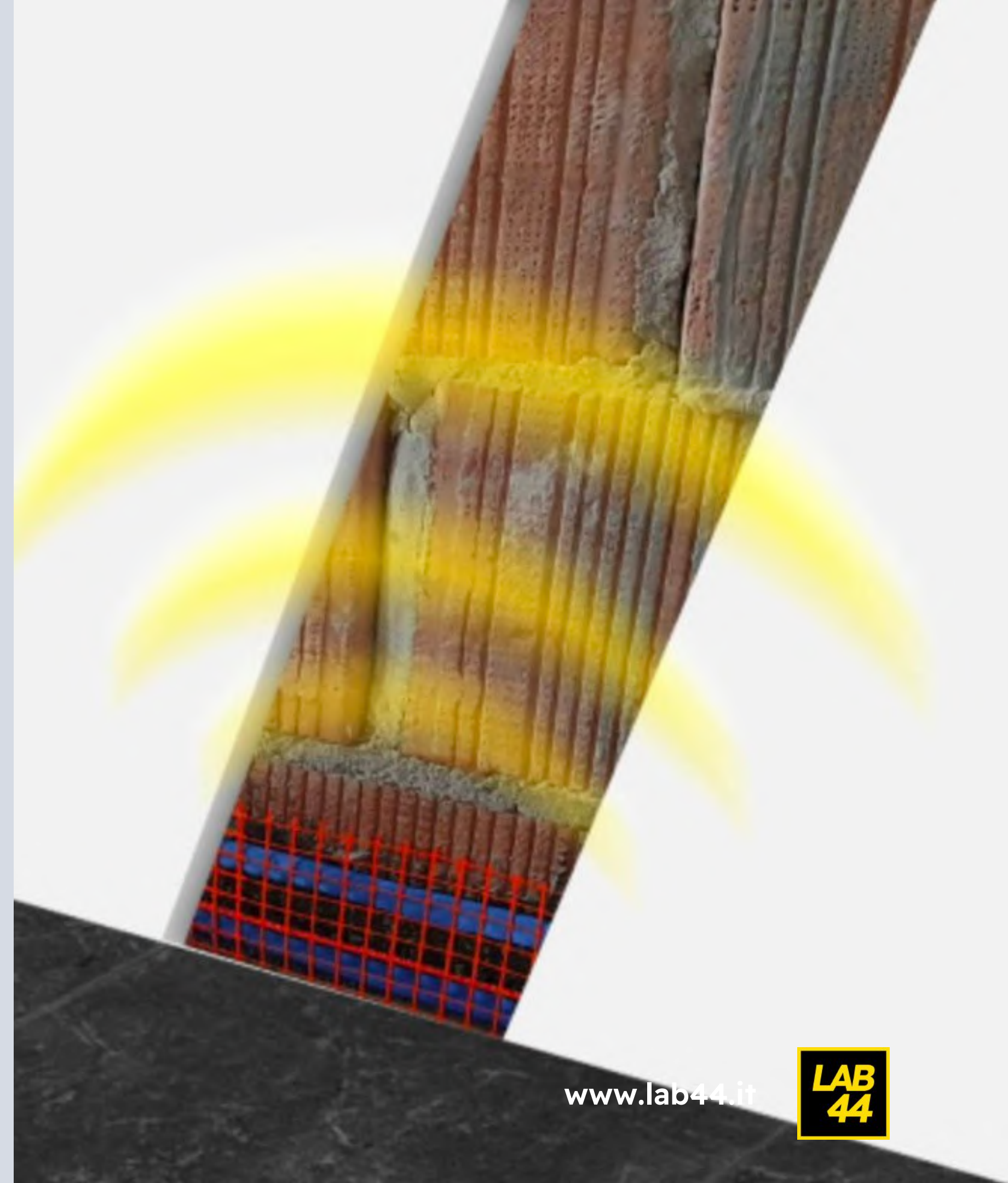



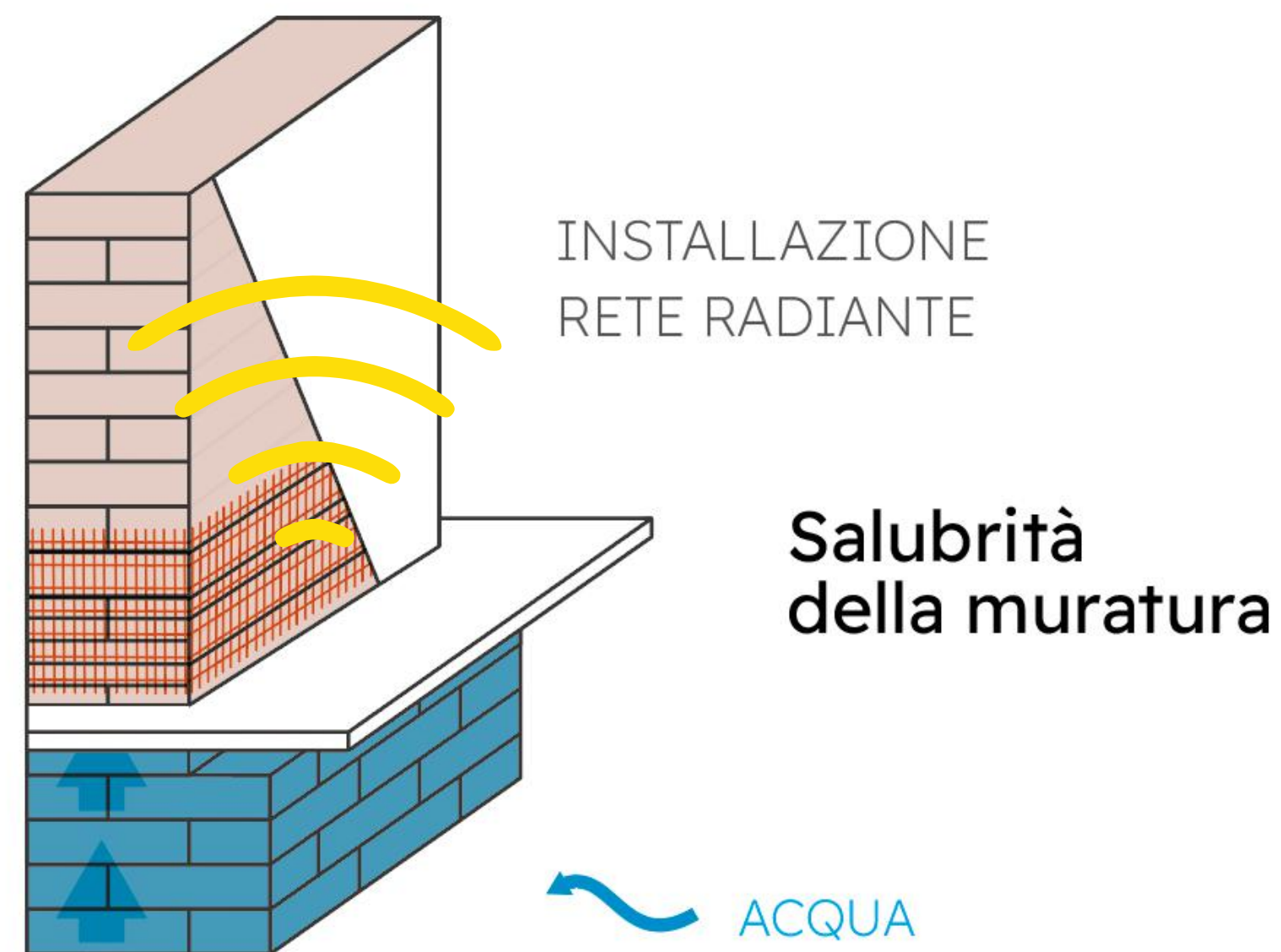
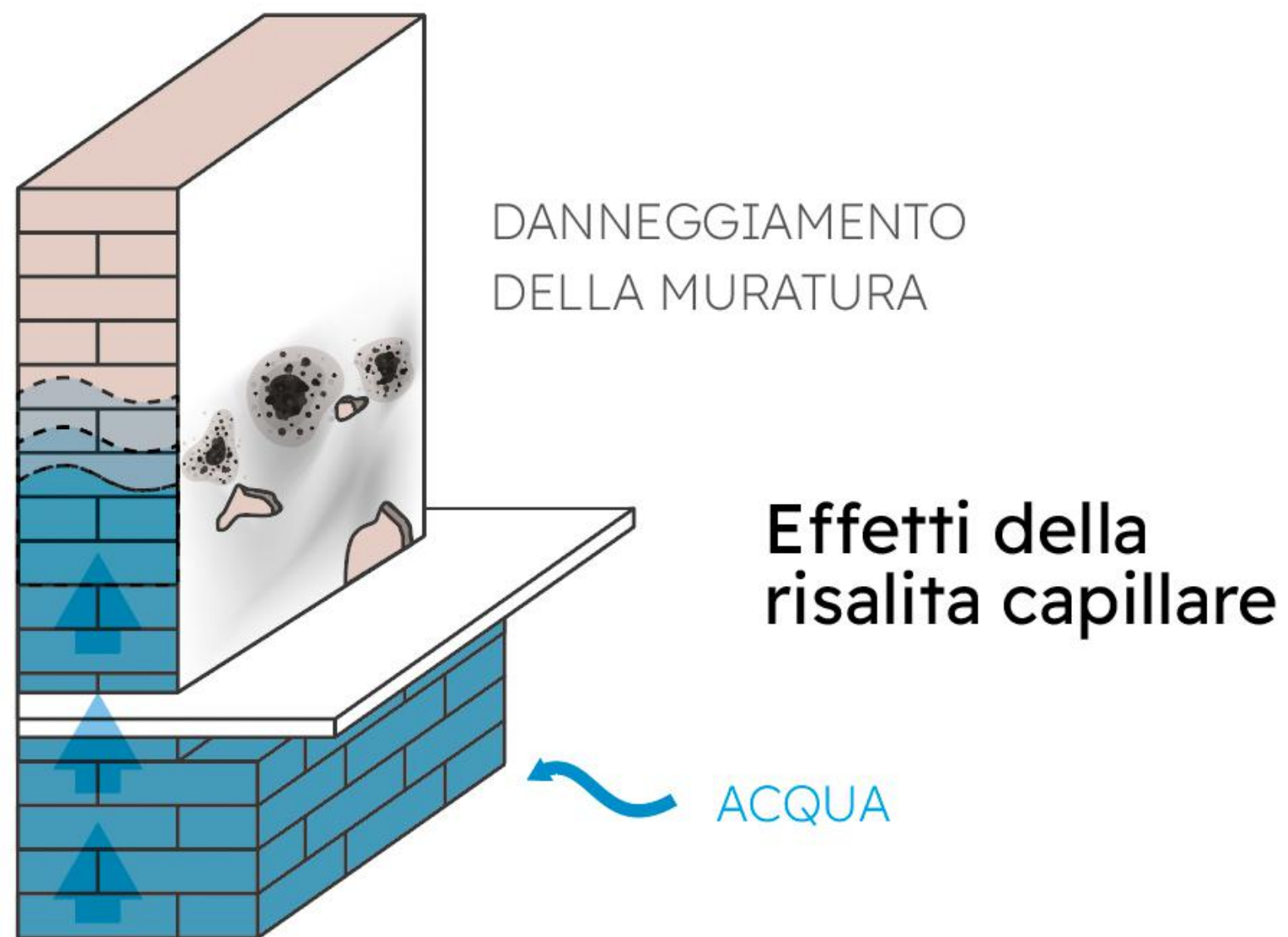



## CASE HISTORY

# ANTIUMIDITÀ VILLA D'EPOCA piano interrato

**Realizzazione su misura**

**Progettista:** VM5 Architetti

**Località:** Rovigo

SOLUZIONI RADIANTI IN FIBRA DI CARBONIO

[www.lab44.it](http://www.lab44.it)



# PROGETTO



SOLUZIONI RADIANTI IN FIBRA DI CARBONIO

[www.lab44.it](http://www.lab44.it)





SOLUZIONI RADIANTI IN FIBRA DI CARBONIO

[www.lab44.it](http://www.lab44.it)





SOLUZIONI RADIANTI IN FIBRA DI CARBONIO

[www.lab44.it](http://www.lab44.it)





## CASE HISTORY

# ANTIUMIDITÀ CAVEDIO ESTERNO

Realizzazione su misura

**Committente:** O.M. P - Officine  
Mazzocco Pagnoni

**Località:** Argelato - Bologna





SOLUZIONI RADIANTI IN FIBRA DI CARBONIO

[www.lab44.it](http://www.lab44.it)



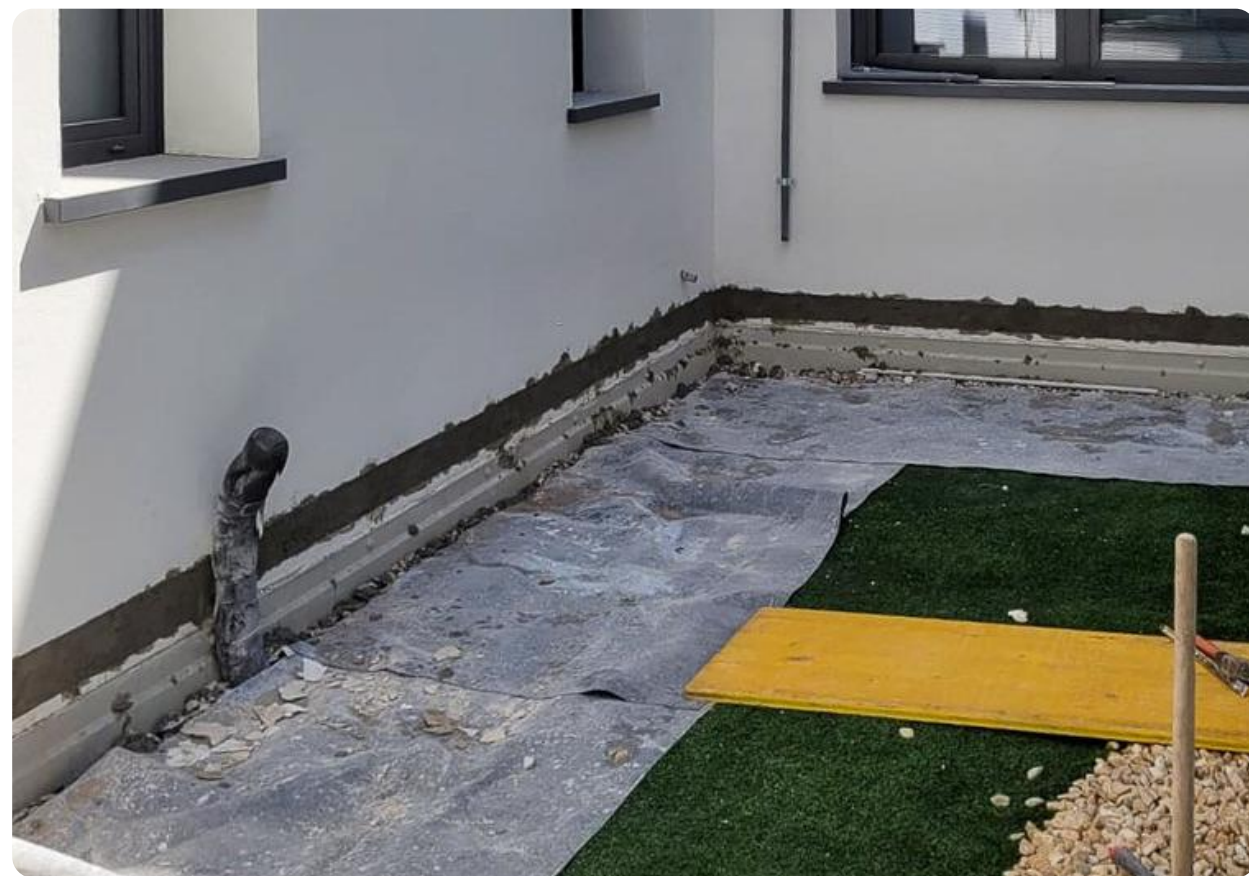
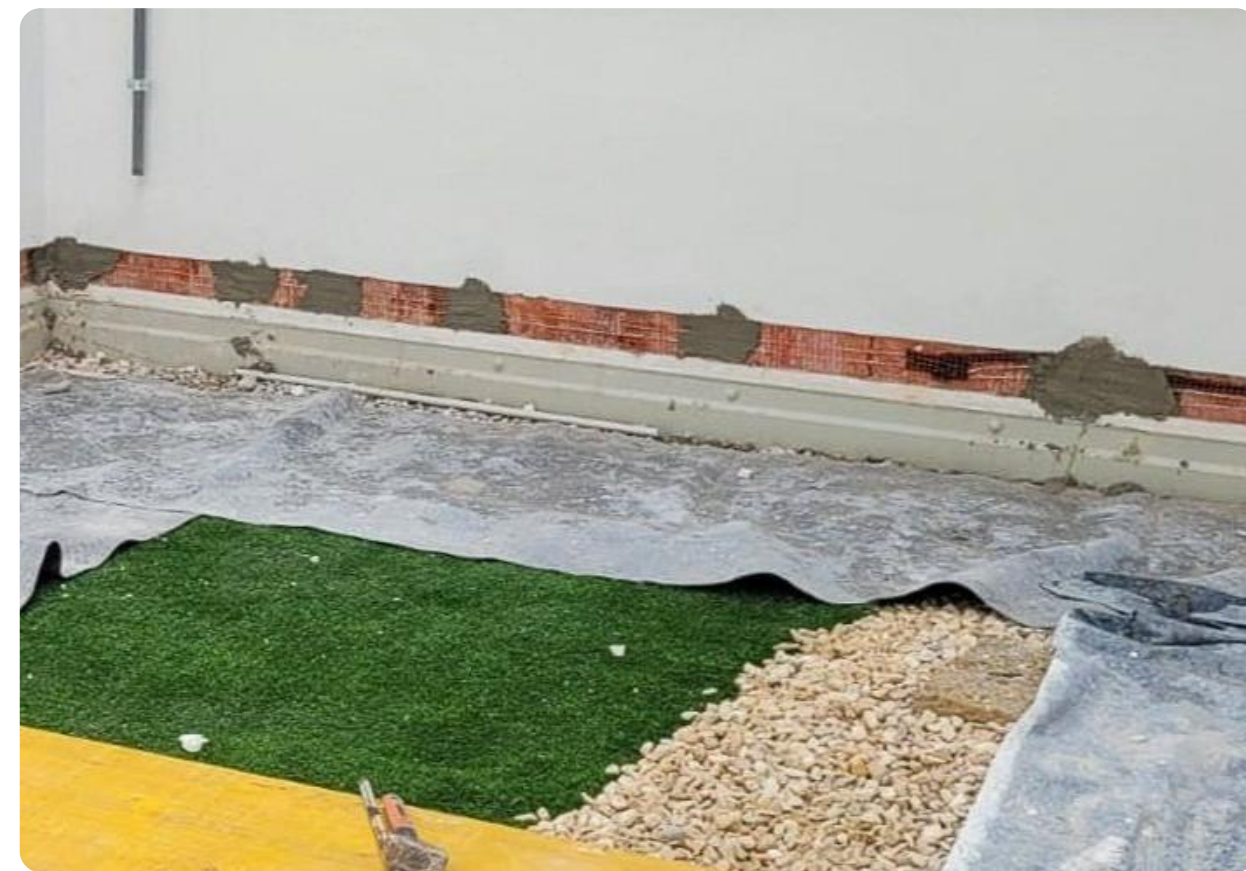

SOLUZIONI RADIANTI IN FIBRA DI CARBONIO

[www.lab44.it](http://www.lab44.it)





## CASE HISTORY

# ANTIUMIDITÀ RESIDENZA INTERNO

Realizzazione su misura

Località: Rovigo

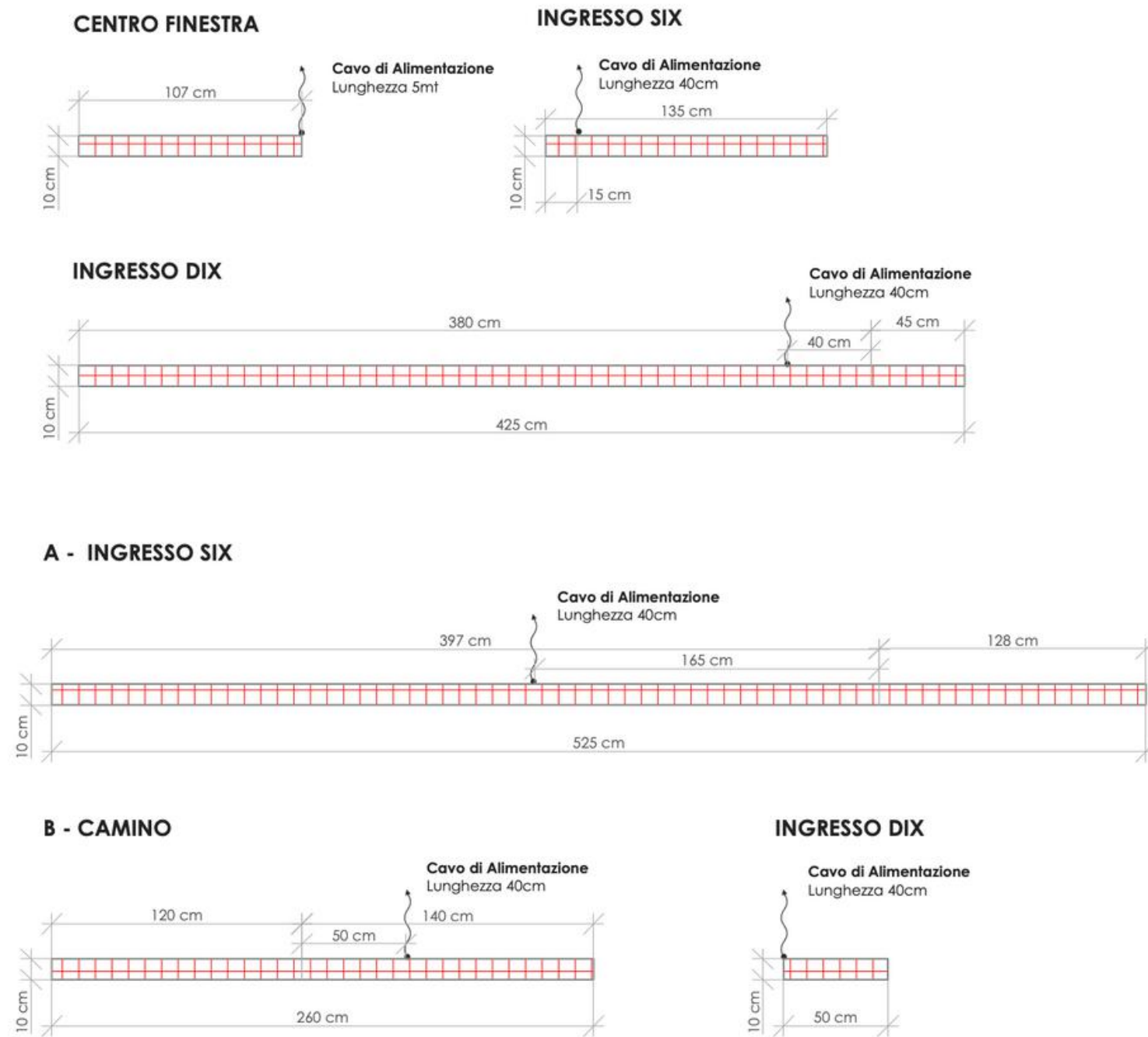

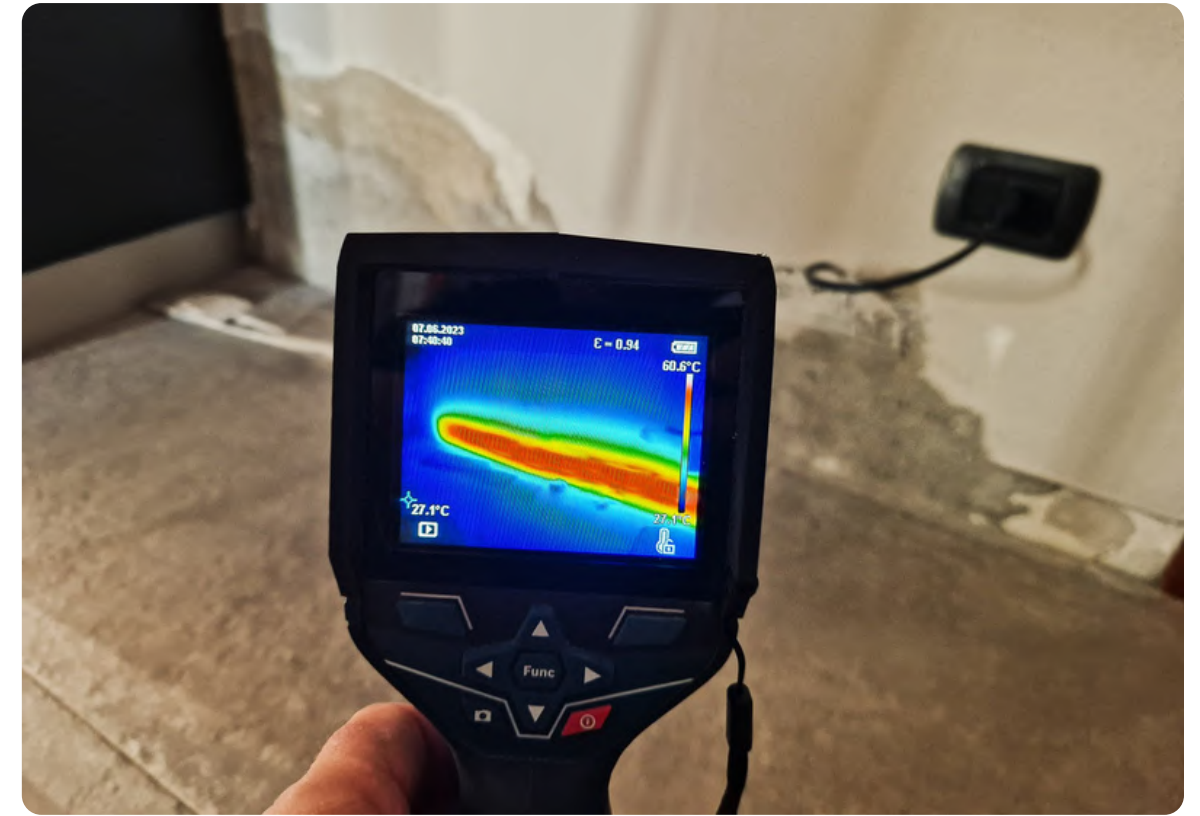

SOLUZIONI RADIANTI IN FIBRA DI CARBONIO

[www.lab44.it](http://www.lab44.it)



# PRODOTTI RADIANTI

## SGHIACCIANTI PER ESTERNI

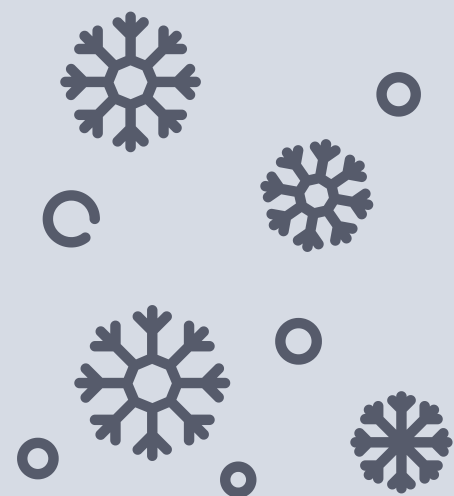

### SICUREZZA AL CALPESTIO ANCHE IN INVERNO

Sciogliono la neve e il ghiaccio in tutte le zone esterne soggette a diventare pericolose o impraticabili durante i periodi freddi

# RETE SGHIACCIANTE SOTTO MASSETTO

## **SPESSORE MINIMO**

Ideale per applicazione sotto il massetto

## **FUNZIONAMENTO AUTOMATICO**

Si aziona autonomamente tramite sonde di rilevamento temperatura integrate

SOLUZIONI RADIANTI IN FIBRA DI CARBONIO

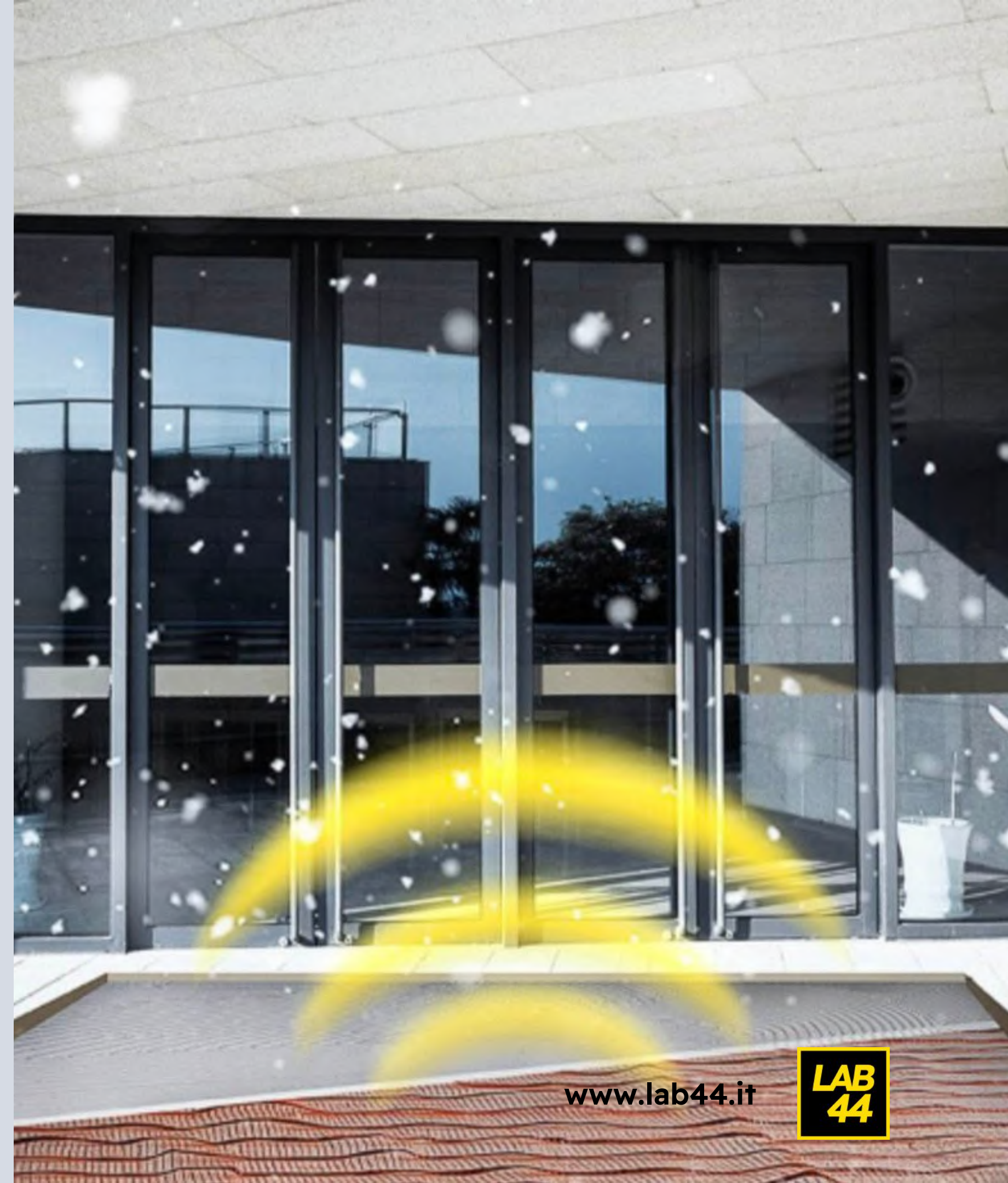

[www.lab44.it](http://www.lab44.it)





## CASE HISTORY

# SGHIACCIANTE ESTERNO SALA CORSI

Realizzazione su misura

**Committente:** O.M. P - Officine  
Mazzocco Pagnoni

**Località:** Argelato - Bologna

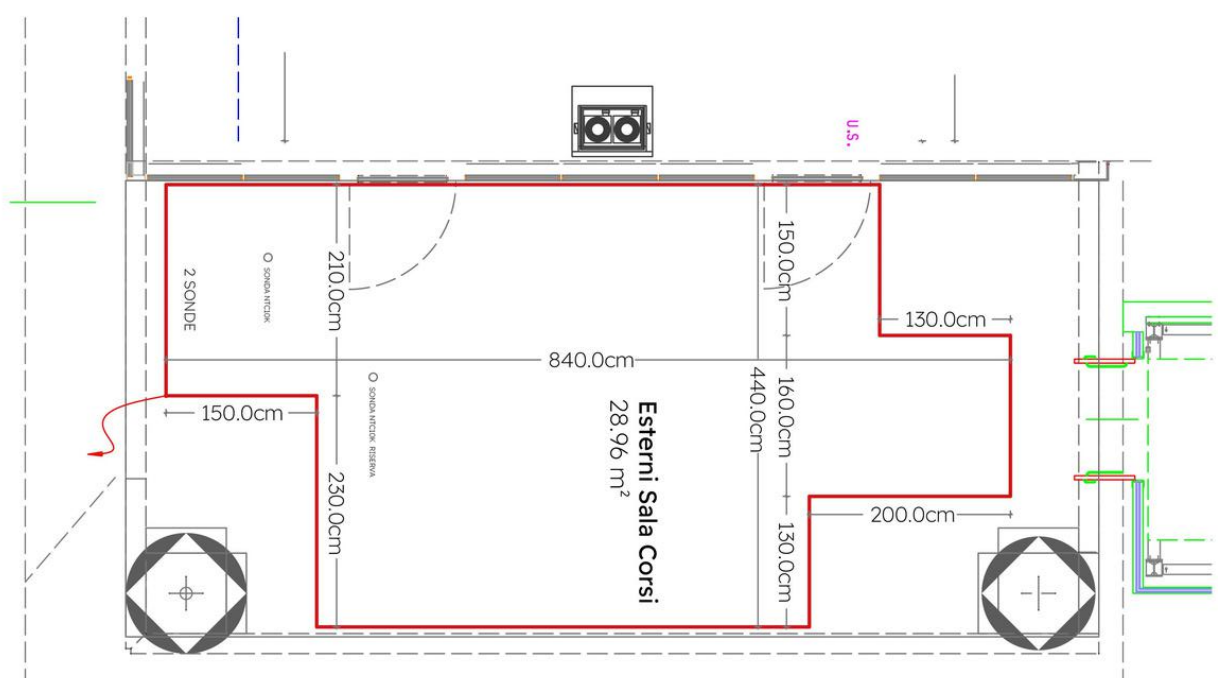

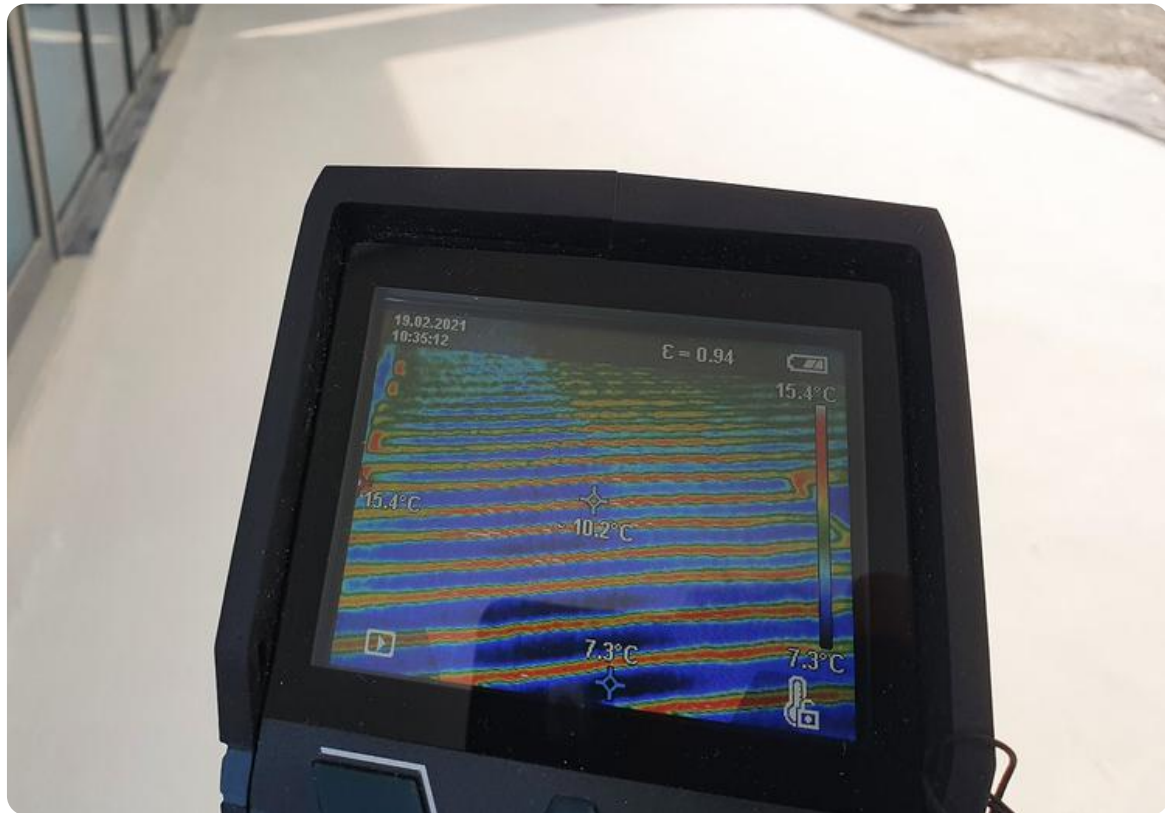

SOLUZIONI RADIANTI IN FIBRA DI CARBONIO

[www.lab44.it](http://www.lab44.it)





## CASE HISTORY

# SGHIACCIANTE TORNELLO INGRESSO

**Realizzazione su misura**

**Committente:** O.M. P - Officine  
Mazzocco Pagnoni

**Località:** Argelato - Bologna

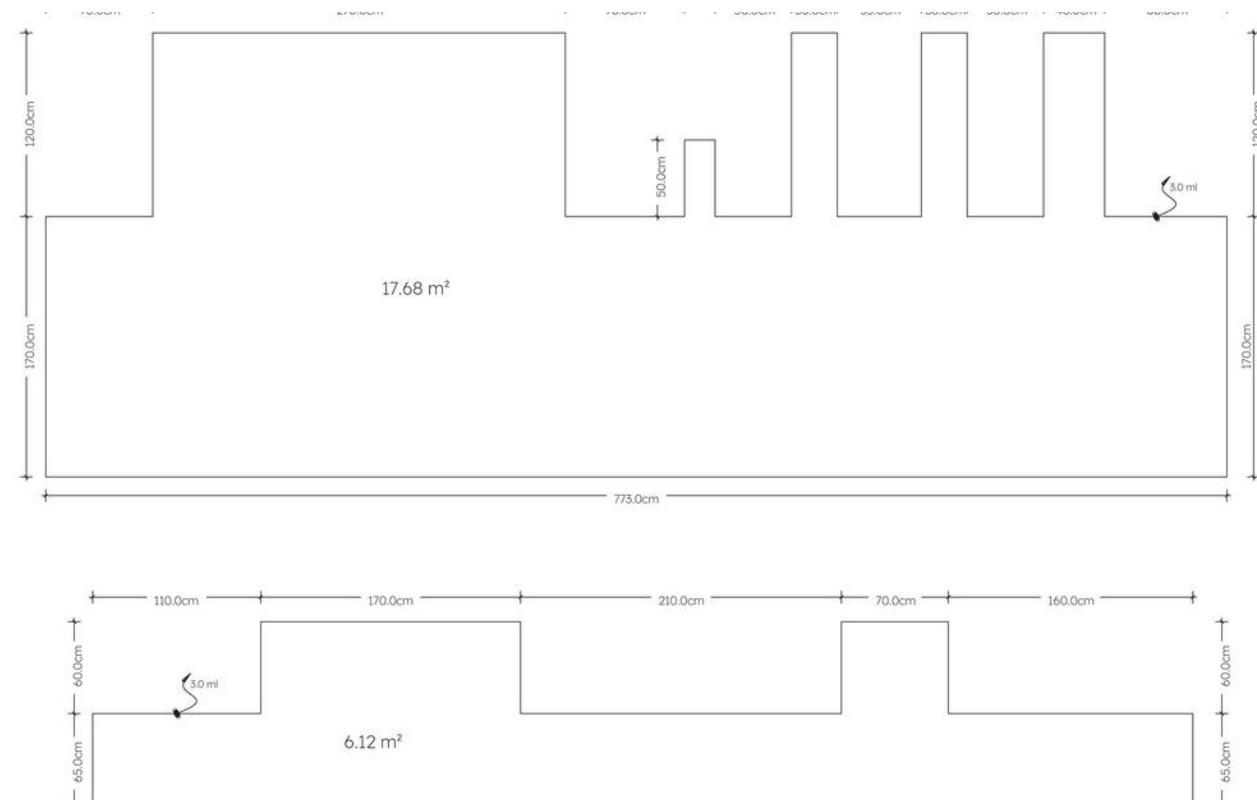

SOLUZIONI RADIANTI IN FIBRA DI CARBONIO

[www.lab44.it](http://www.lab44.it)



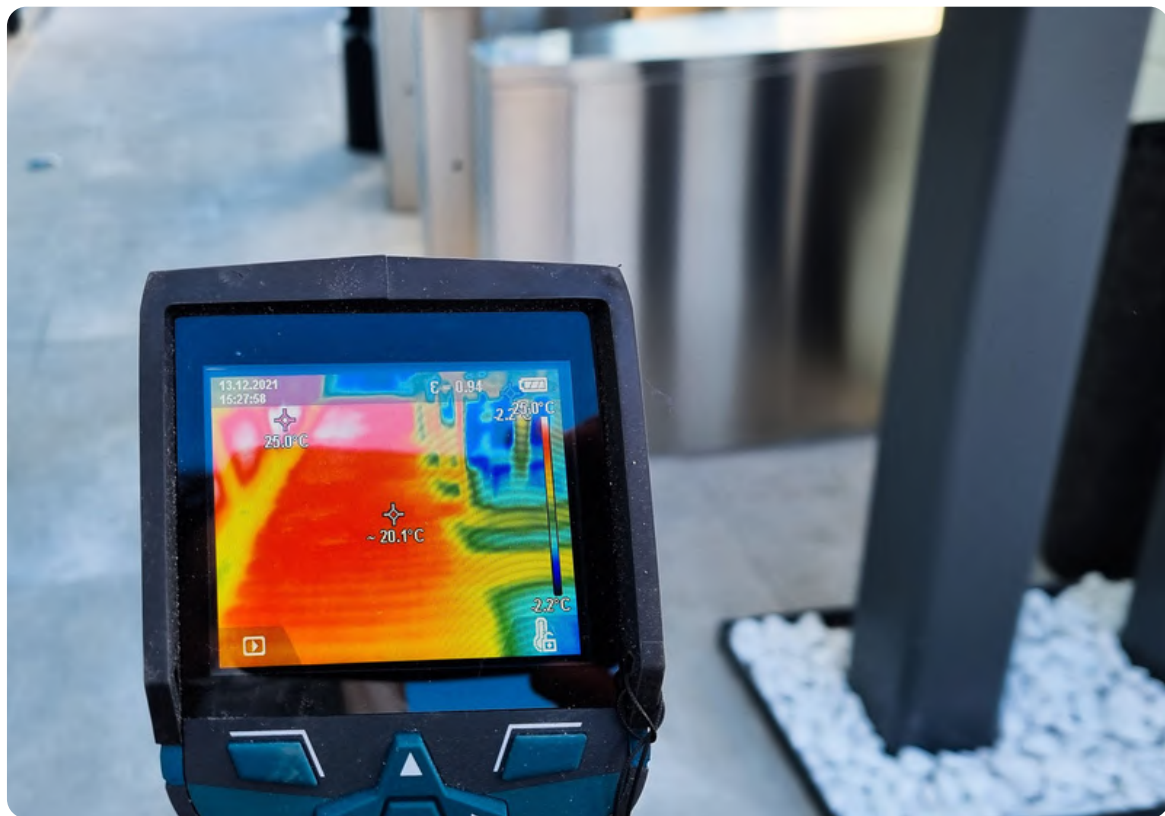

SOLUZIONI RADIANTI IN FIBRA DI CARBONIO

[www.lab44.it](http://www.lab44.it)





# BOX RADIANTE

PAVIMENTI  
SOPRAELEVATI

## NESSUN INGOMBRO

La pavimentazione rimane  
completamente disponibile all'utilizzo

## AZIONABILE A NECESSITA'

Sistema predisposto in linee da azionare  
secondo la necessità

## PAVIMENTAZIONE SEMPRE ISPEZIONABILE

SOLUZIONI RADIANTI IN FIBRA DI CARBONIO



[www.lab44.it](http://www.lab44.it)





## CASE HISTORY

# SGHIACCIANTE SPA HOTEL FANTELLI

**Realizzazione su misura**

**Committente:** Hotel Fantelli

**Località:** Folgarida - Val di Sole



SOLUZIONI RADIANTI IN FIBRA DI CARBONIO

[www.lab44.it](http://www.lab44.it)



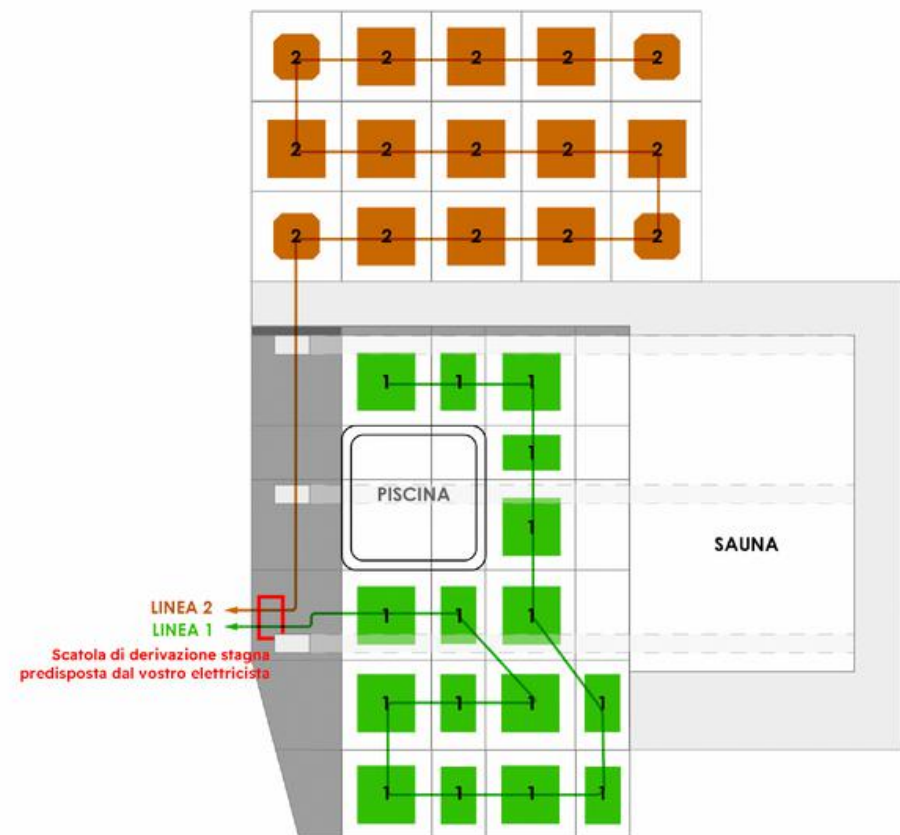

SOLUZIONI RADIANTI IN FIBRA DI CARBONIO

[www.lab44.it](http://www.lab44.it)



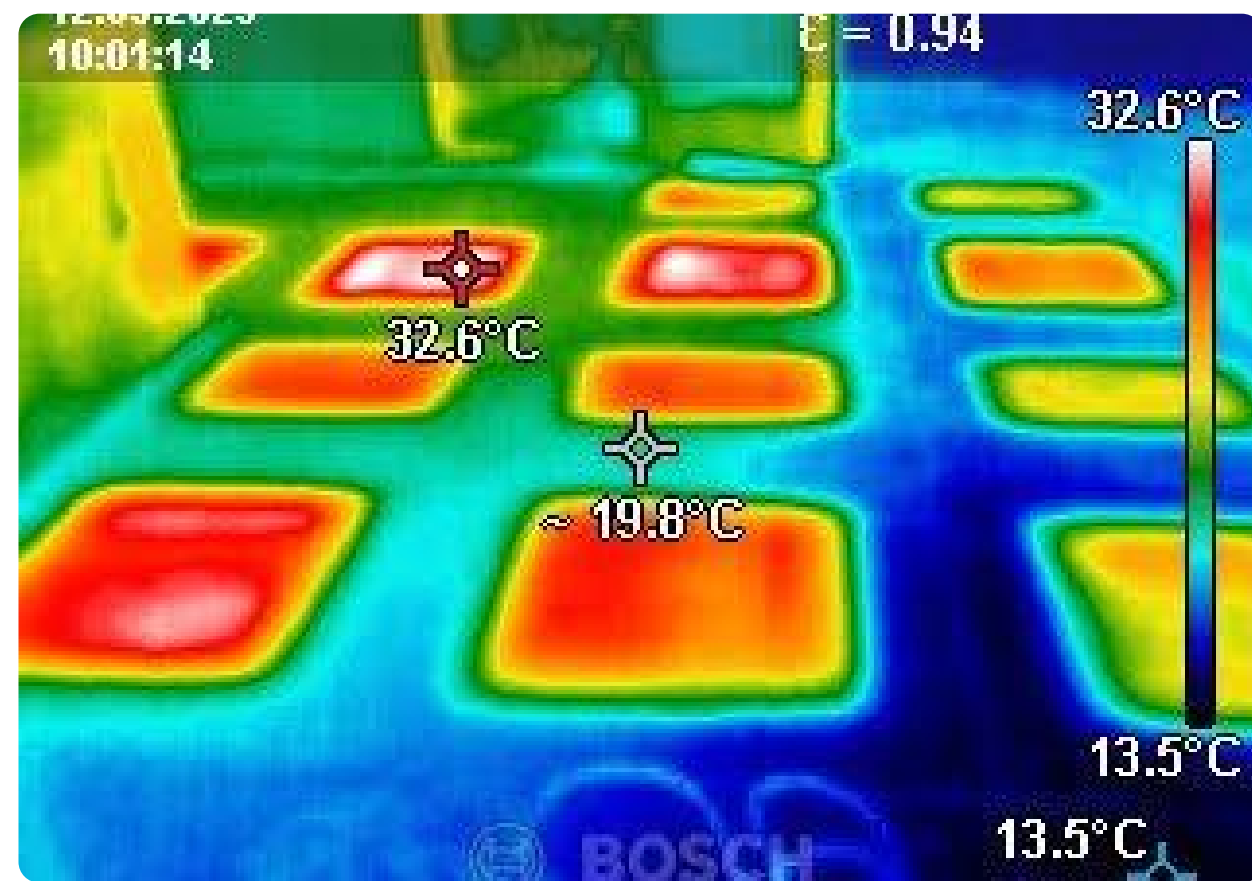
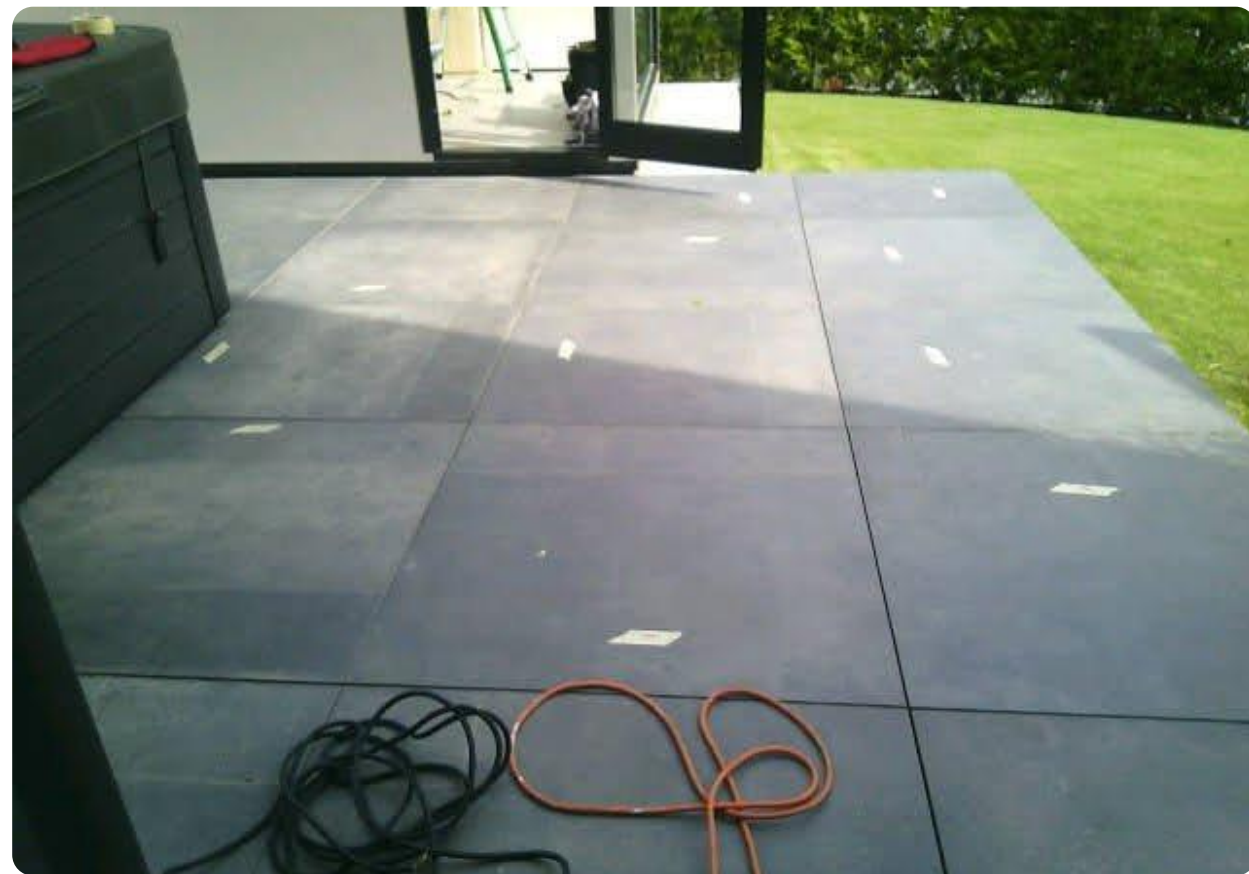

SOLUZIONI RADIANTI IN FIBRA DI CARBONIO

[www.lab44.it](http://www.lab44.it)





CASE HISTORY

# SGHIACCIANTE TERRAZZA ATTICO

Località:

Madonna di Campiglio



SOLUZIONI RADIANTI IN FIBRA DI CARBONIO

[www.lab44.it](http://www.lab44.it)



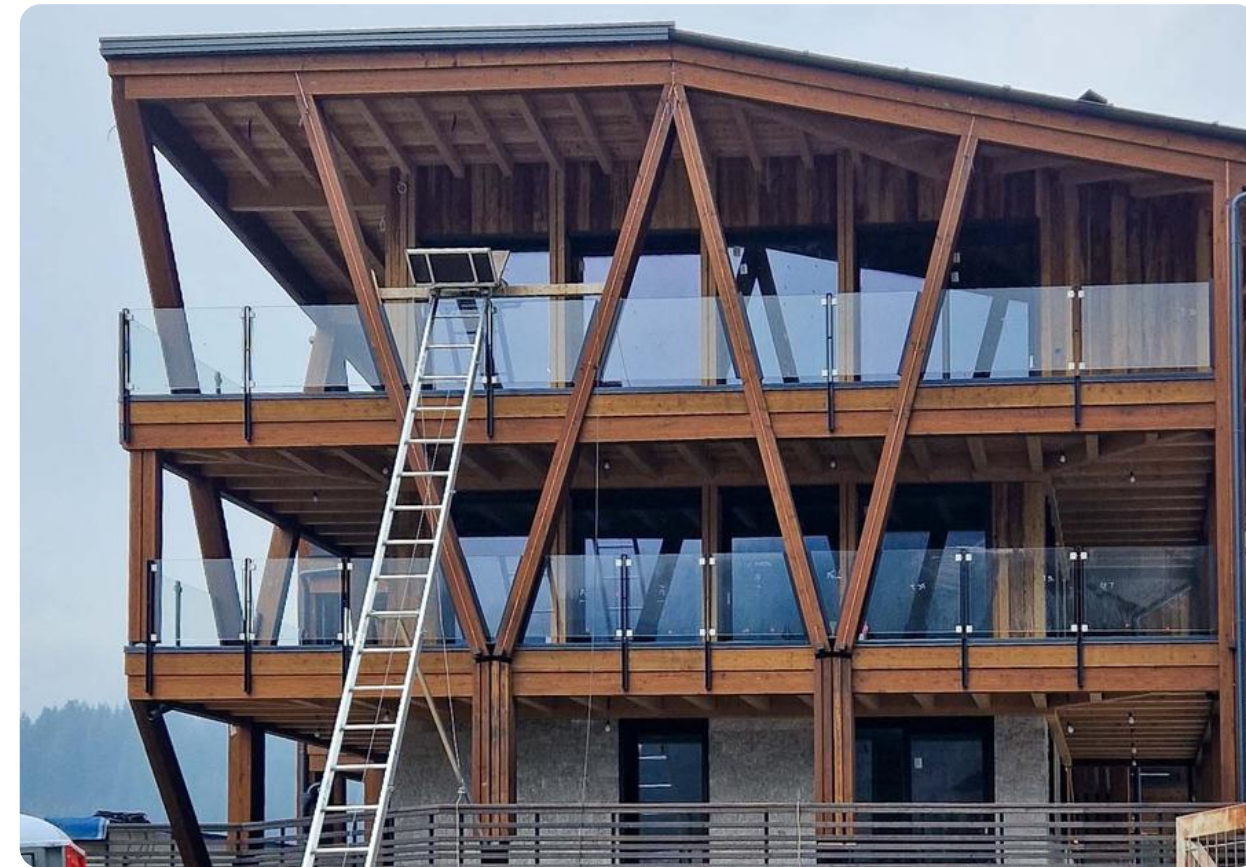

SOLUZIONI RADIANTI IN FIBRA DI CARBONIO

[www.lab44.it](http://www.lab44.it)



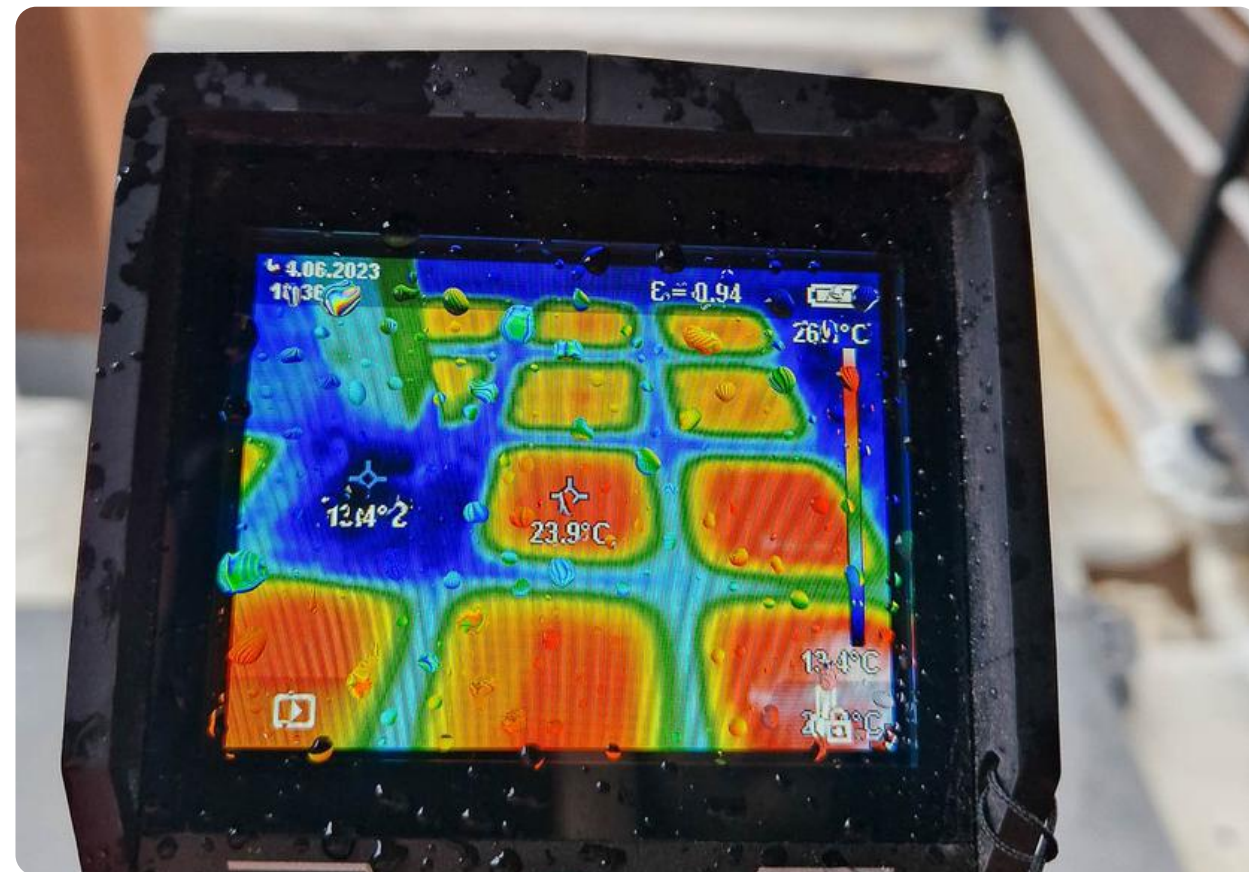
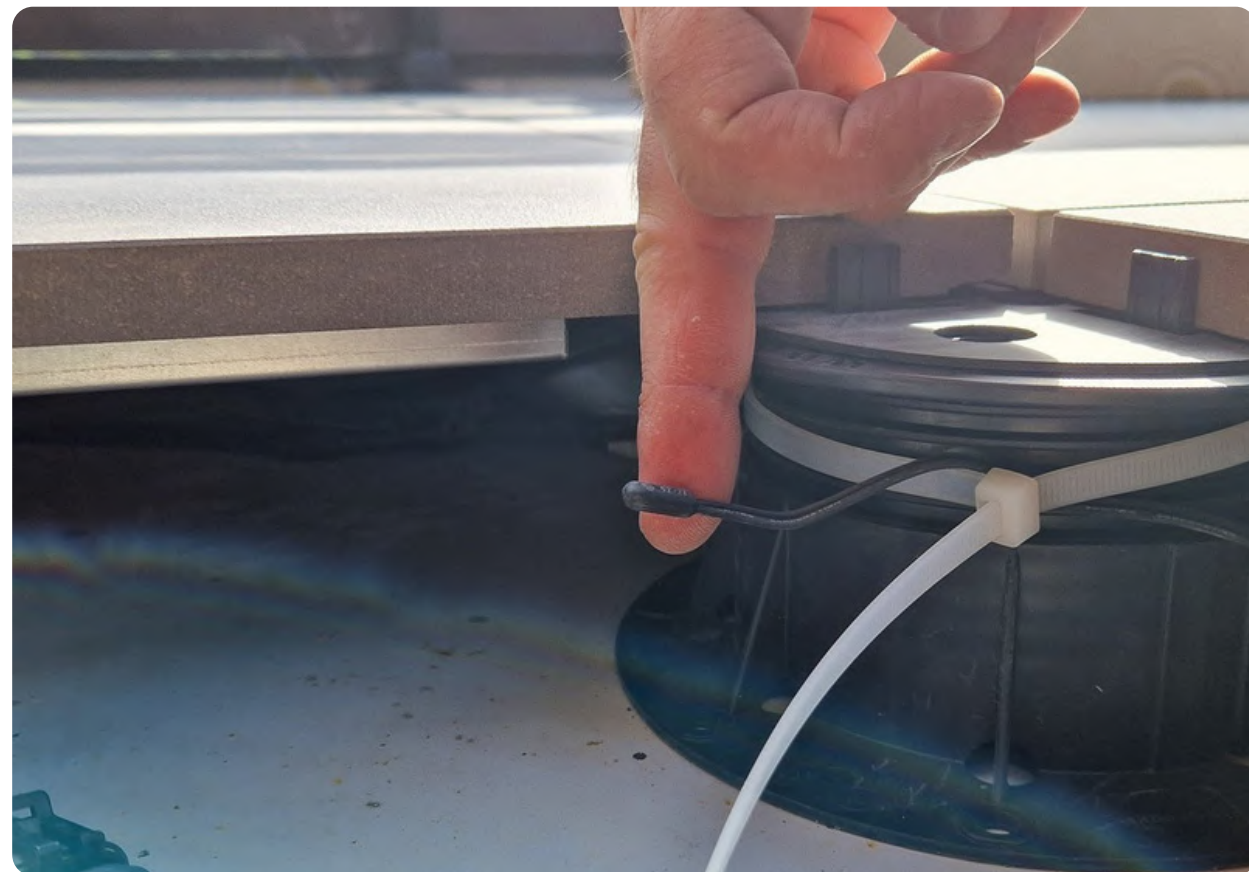
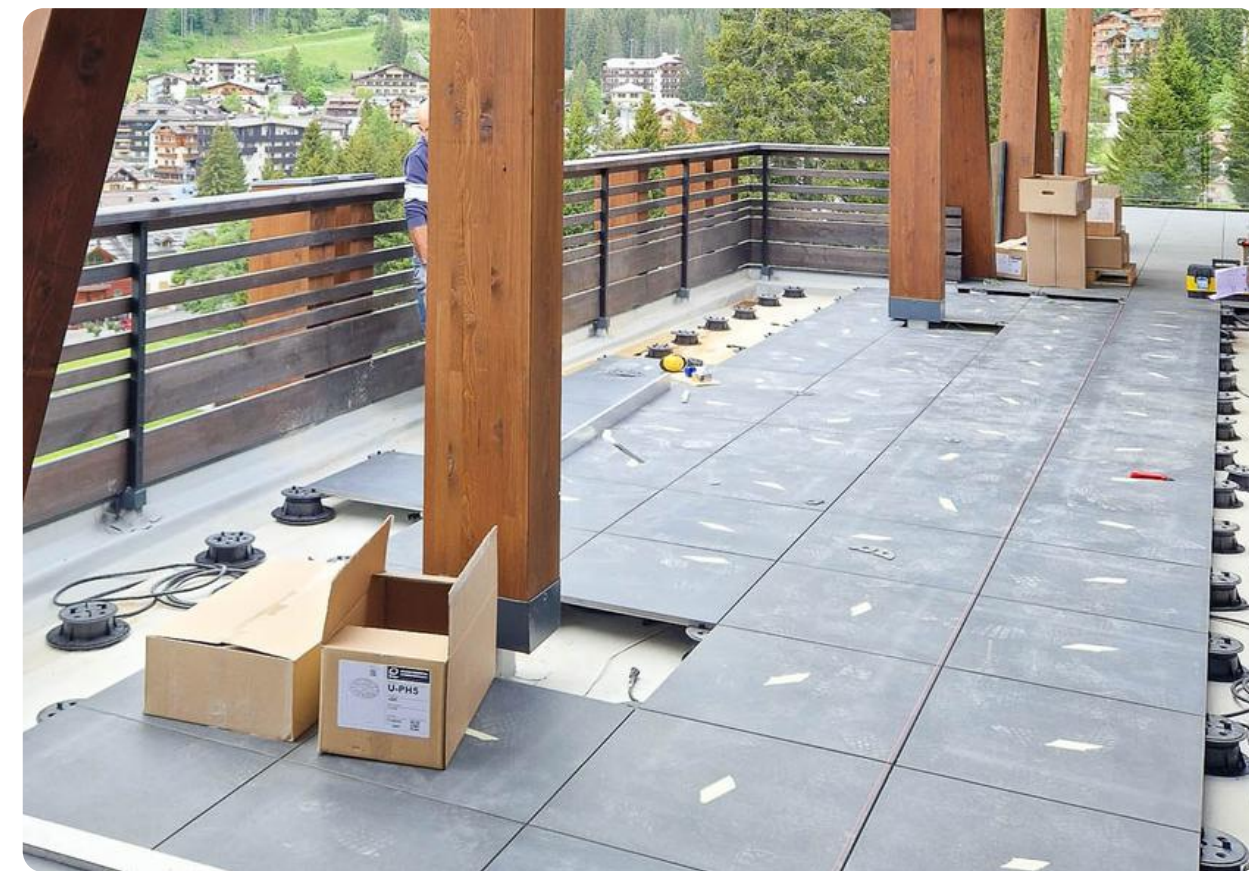
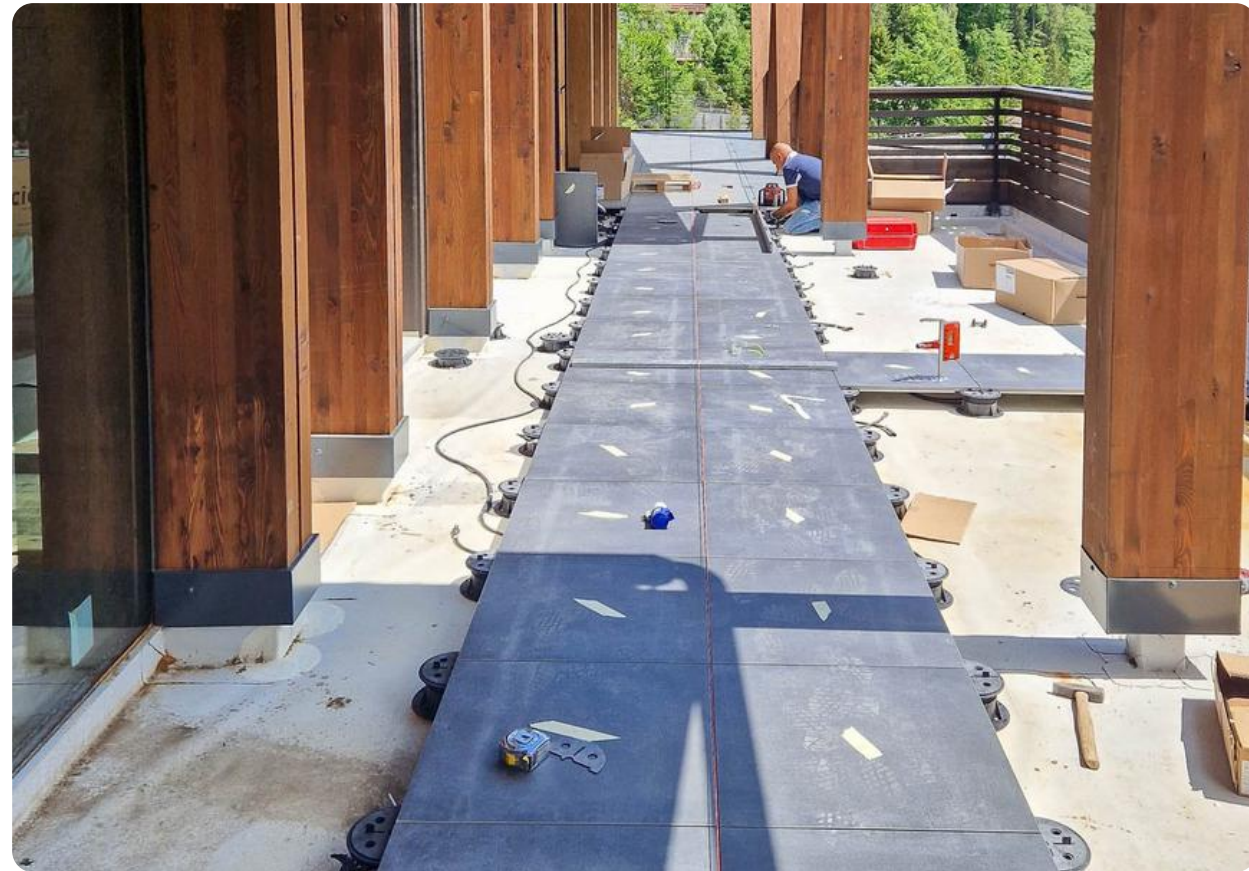

SOLUZIONI RADIANTI IN FIBRA DI CARBONIO

[www.lab44.it](http://www.lab44.it)





## CASE HISTORY

# DEHORS

**Committente:** DolceVita Italian Bar

**Località:** Vicenza

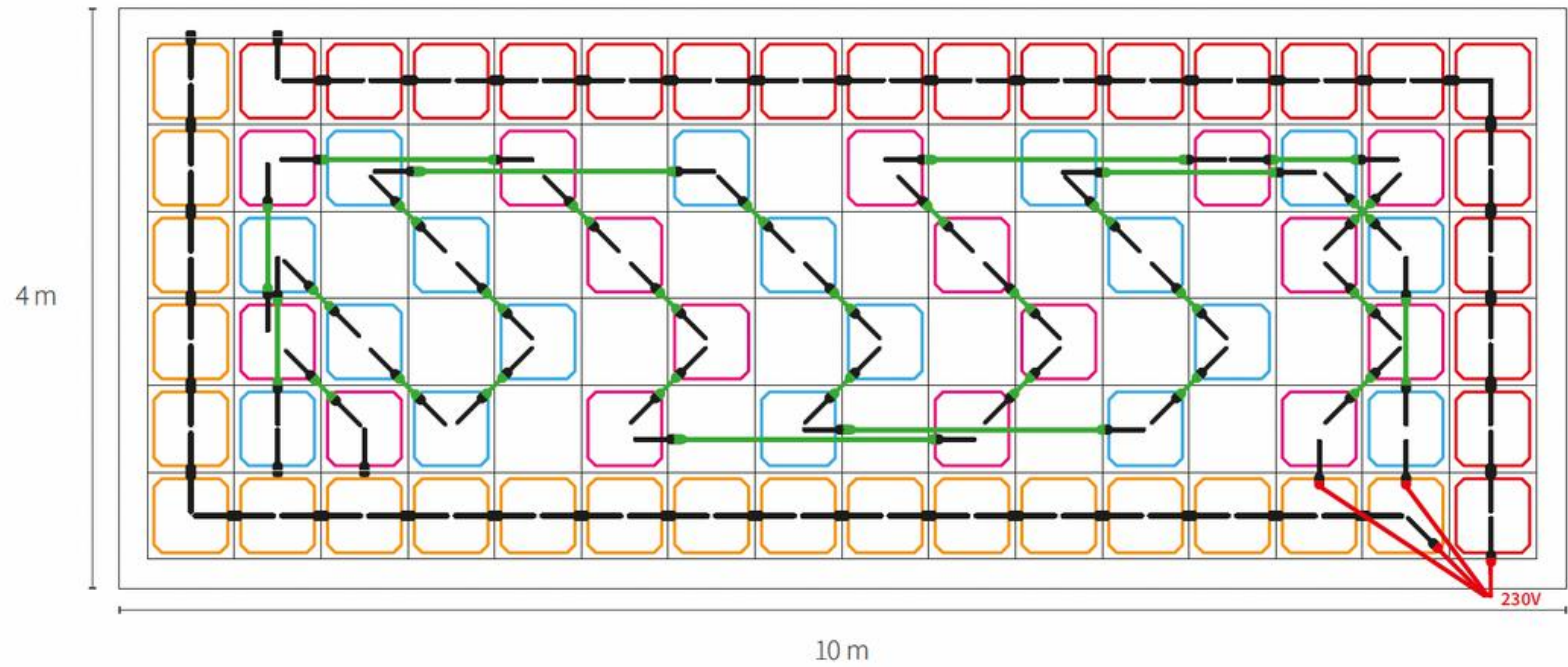

SOLUZIONI RADIANTI IN FIBRA DI CARBONIO

[www.lab44.it](http://www.lab44.it)







SOLUZIONI RADIANTI IN FIBRA DI CARBONIO

[www.lab44.it](http://www.lab44.it)



# PIASTRA SOTTO DECKING

## PAVIMENTAZIONI WPC

### **NESSUN INGOMBRO**

La pavimentazione rimane  
completamente disponibile all'utilizzo

### **MODULABILE A PROGETTO**

Sistema predisposto in linee azionabili a  
necessità

### **INSTALLAZIONE RAPIDA**

Contestuale alla posa decking

SOLUZIONI RADIANTI IN FIBRA DI CARBONIO

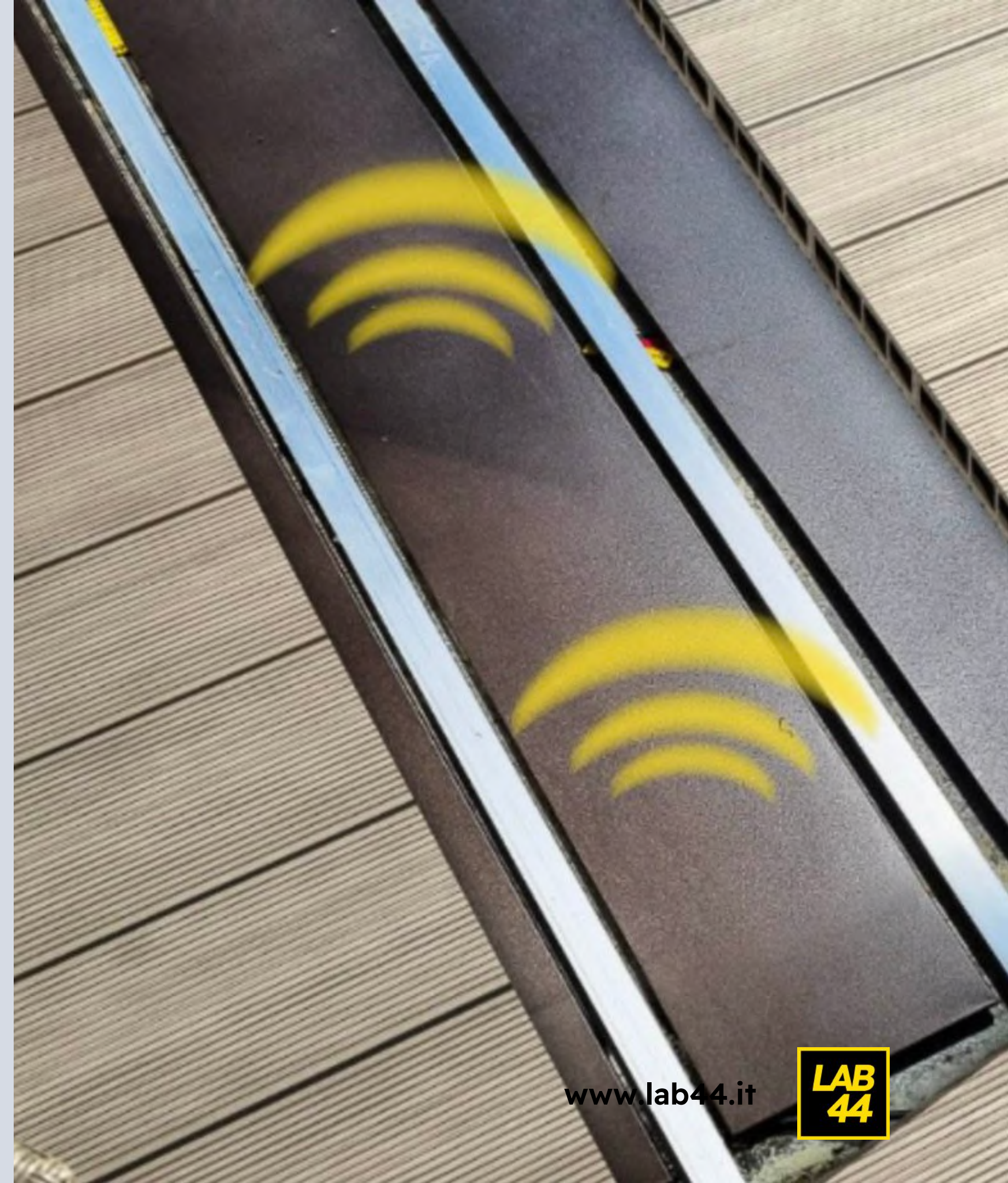

[www.lab44.it](http://www.lab44.it)





## CASE HISTORY

# ACQUARIO DI GENOVA

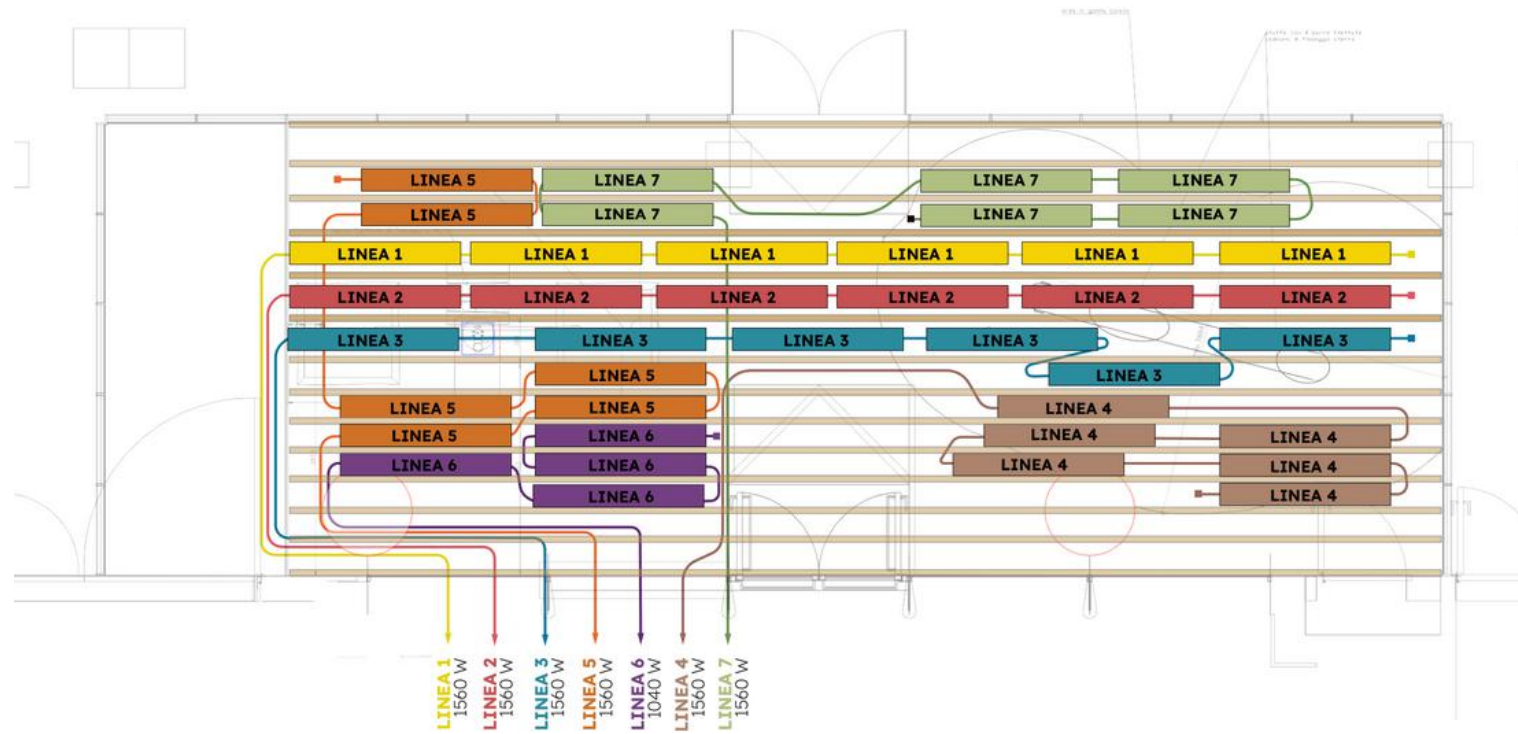

**Progettista:** Arch. Renzo Piano

**Località:** Genova

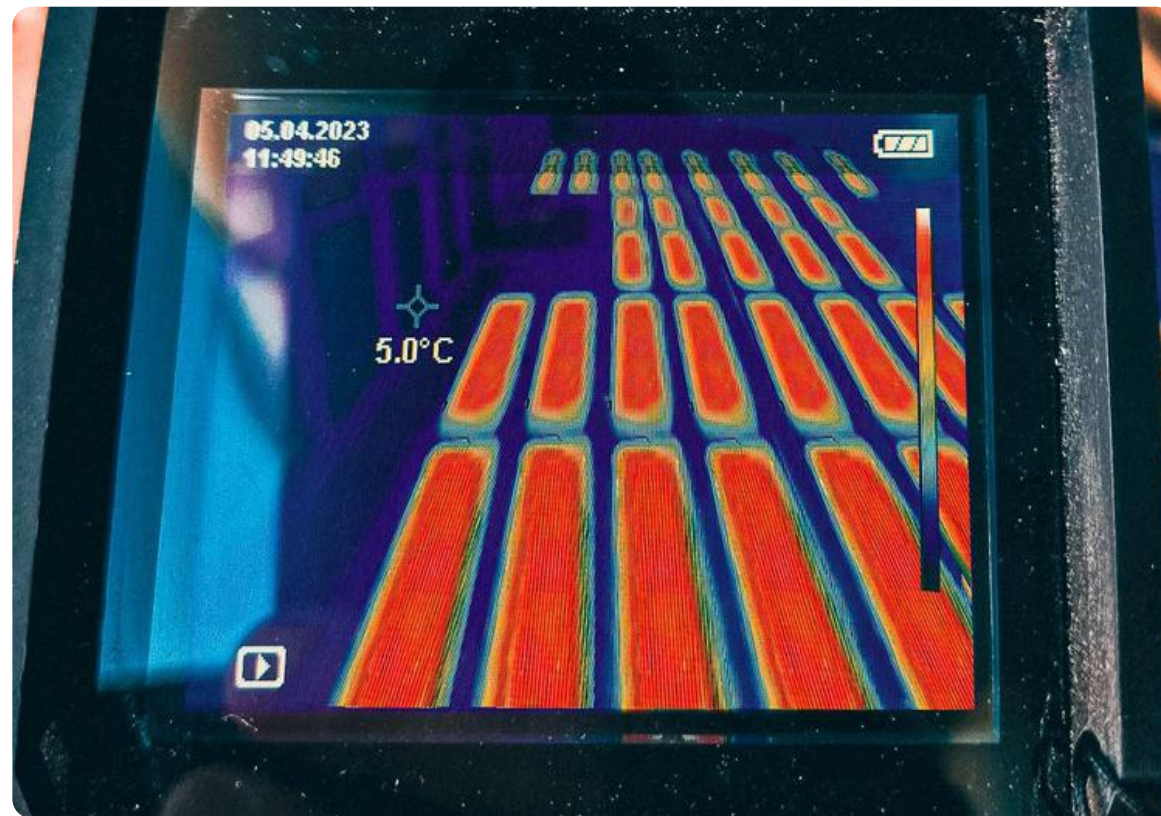
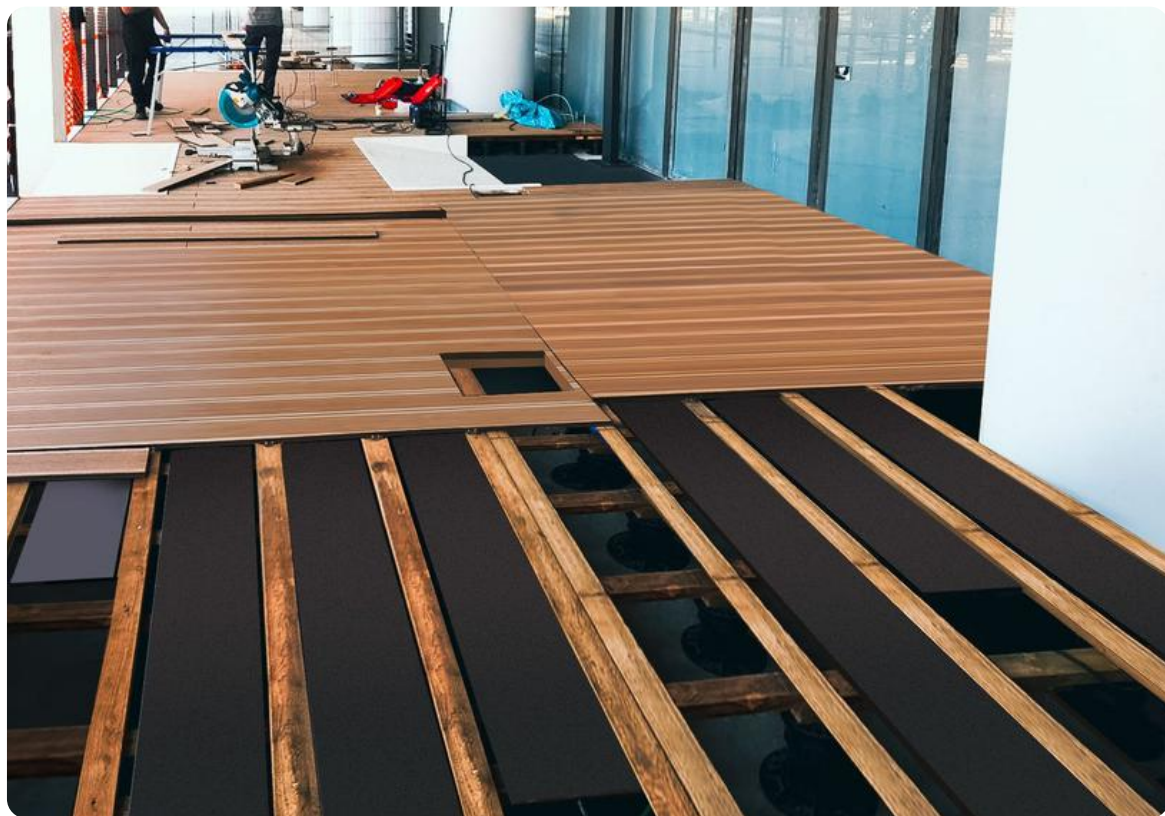

SOLUZIONI RADIANTI IN FIBRA DI CARBONIO

[www.lab44.it](http://www.lab44.it)





## CASE HISTORY

# SGHIACCIANTE DECKING ALTA MONTAGNA

**Committente:** Albergo Fiamme Gialle

**Località:** Passo Rolle - Trento

SOLUZIONI RADIANTI IN FIBRA DI CARBONIO

[www.lab44.it](http://www.lab44.it)



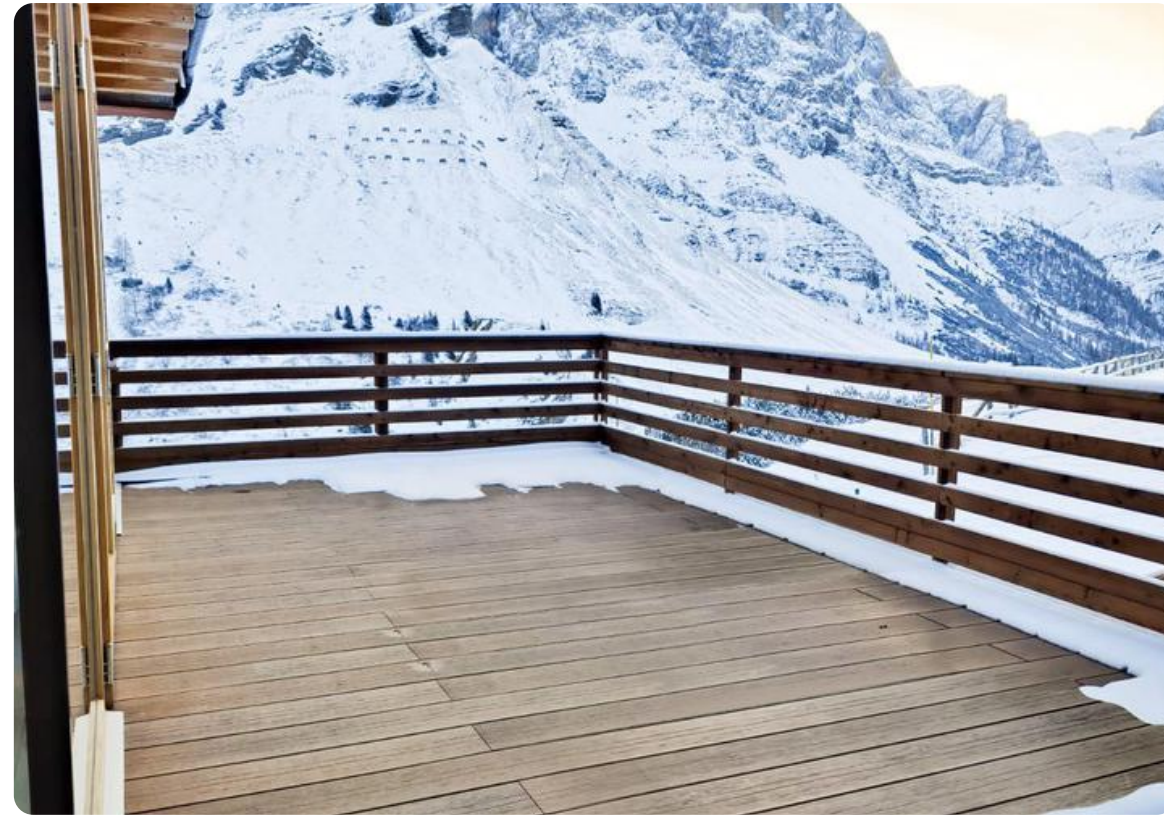
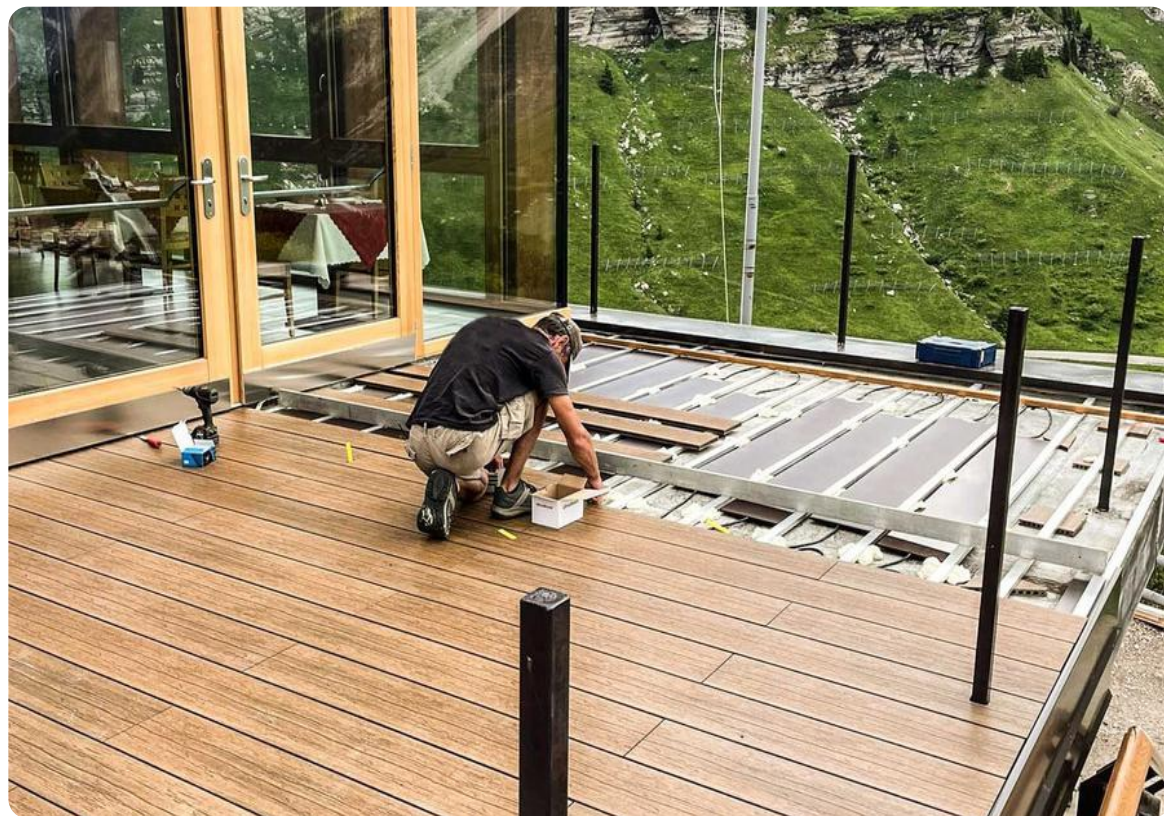

SOLUZIONI RADIANTI IN FIBRA DI CARBONIO

[www.lab44.it](http://www.lab44.it)



# PRODOTTI RADIANTI

## TAPPETO RADIANTE

SOLUZIONE AMOVIBILE

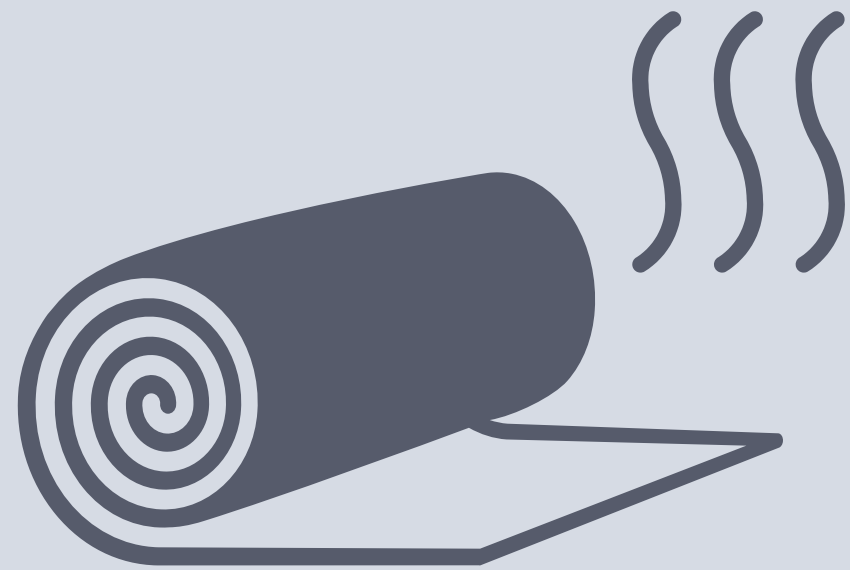

Irraggia piccoli e grandi spazi con un calore localizzato per le persone sulla superficie.

# TAPPETO RADIANTE

## **REALIZZATO SU MISURA**

Nelle dimensioni e nella potenza

## **VASTA GAMMA DI COLORI A SCELTA**

- **PER INTERNI ED ESTERNI**
- **EVENTI TEMPORANEI**
- **AMBIENTI DIFFICILMENTE  
RISCALDABILI**
- **EDIFICI MONUMENTALI/STORICI**

SOLUZIONI RADIANTI IN FIBRA DI CARBONIO

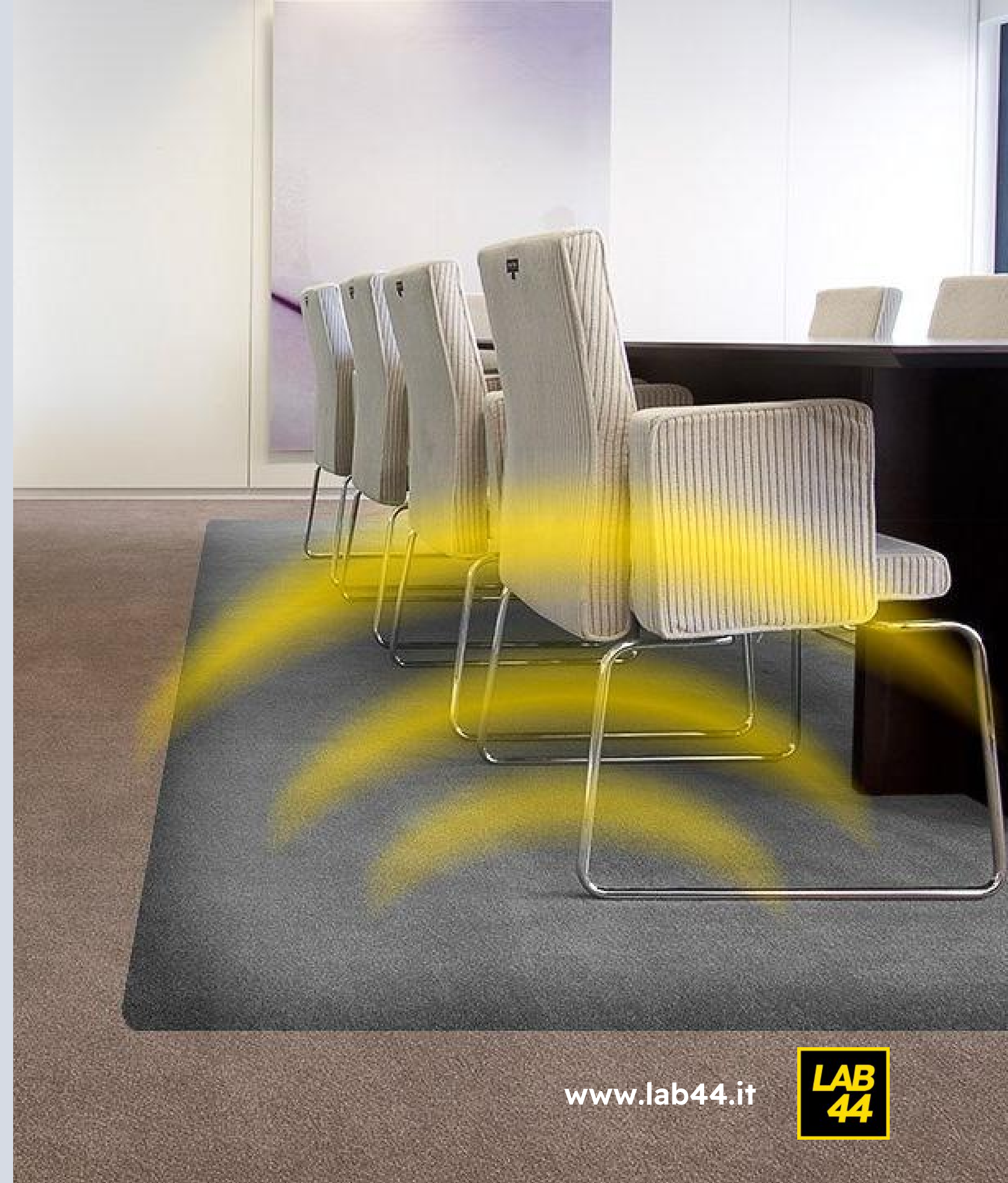

[www.lab44.it](http://www.lab44.it)





## CASE HISTORY

# LA SACRA SINDONE

Torino

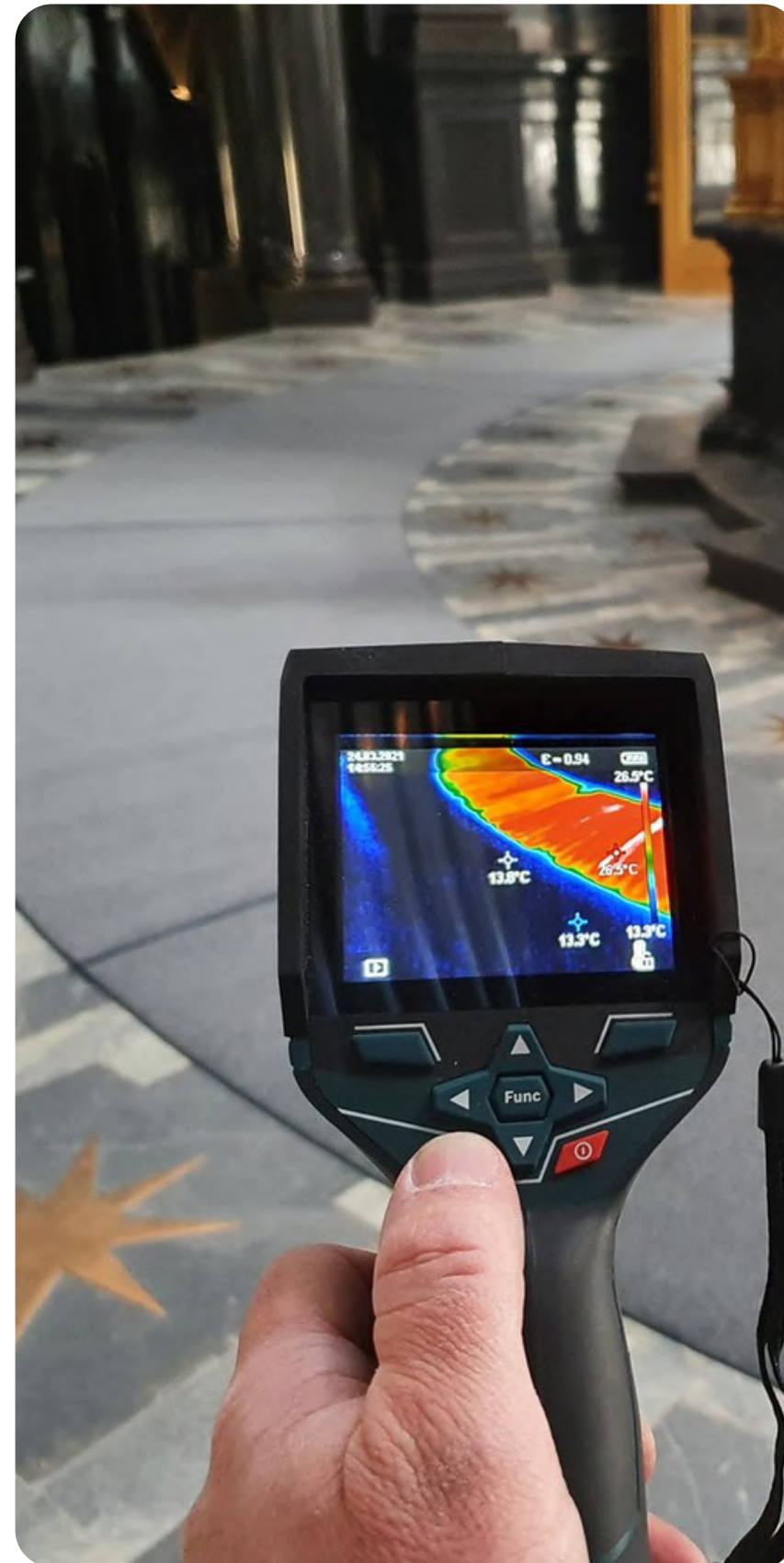

SOLUZIONI RADIANTI IN FIBRA DI CARBONIO

[www.lab44.it](http://www.lab44.it)



## CASE HISTORY

# DEHORS

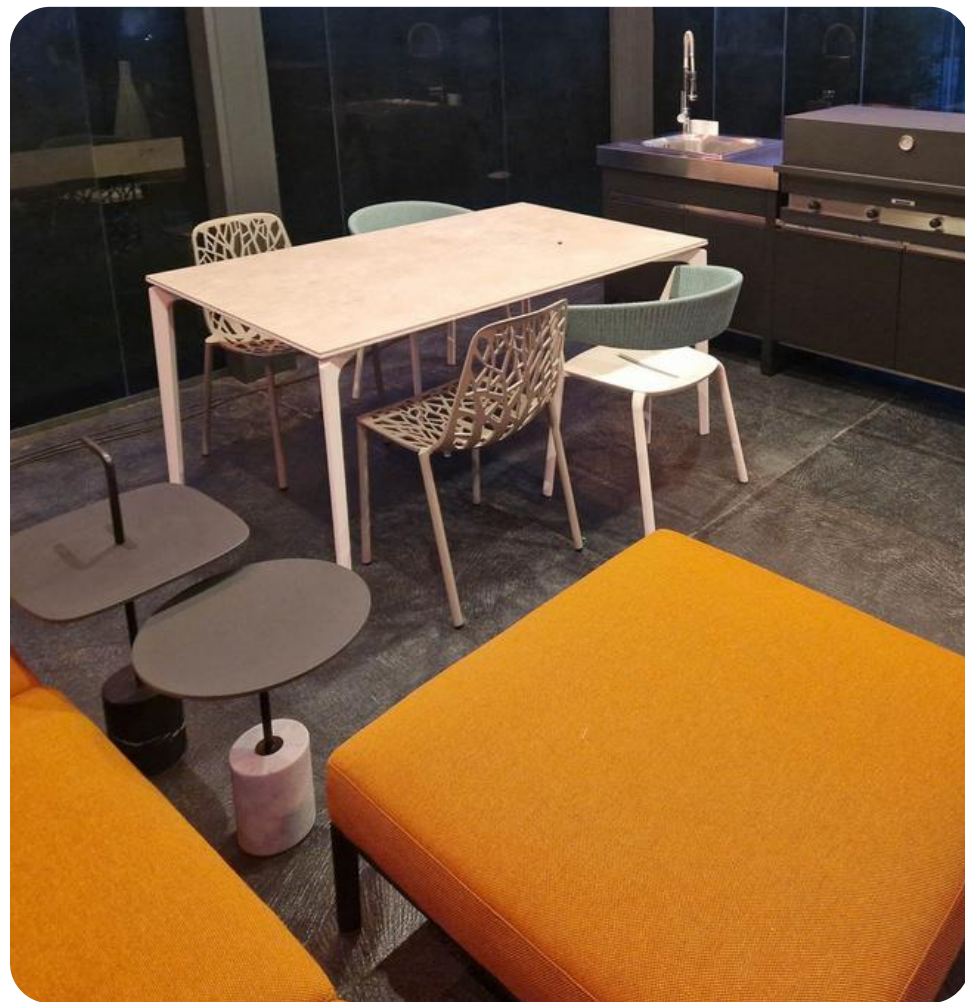
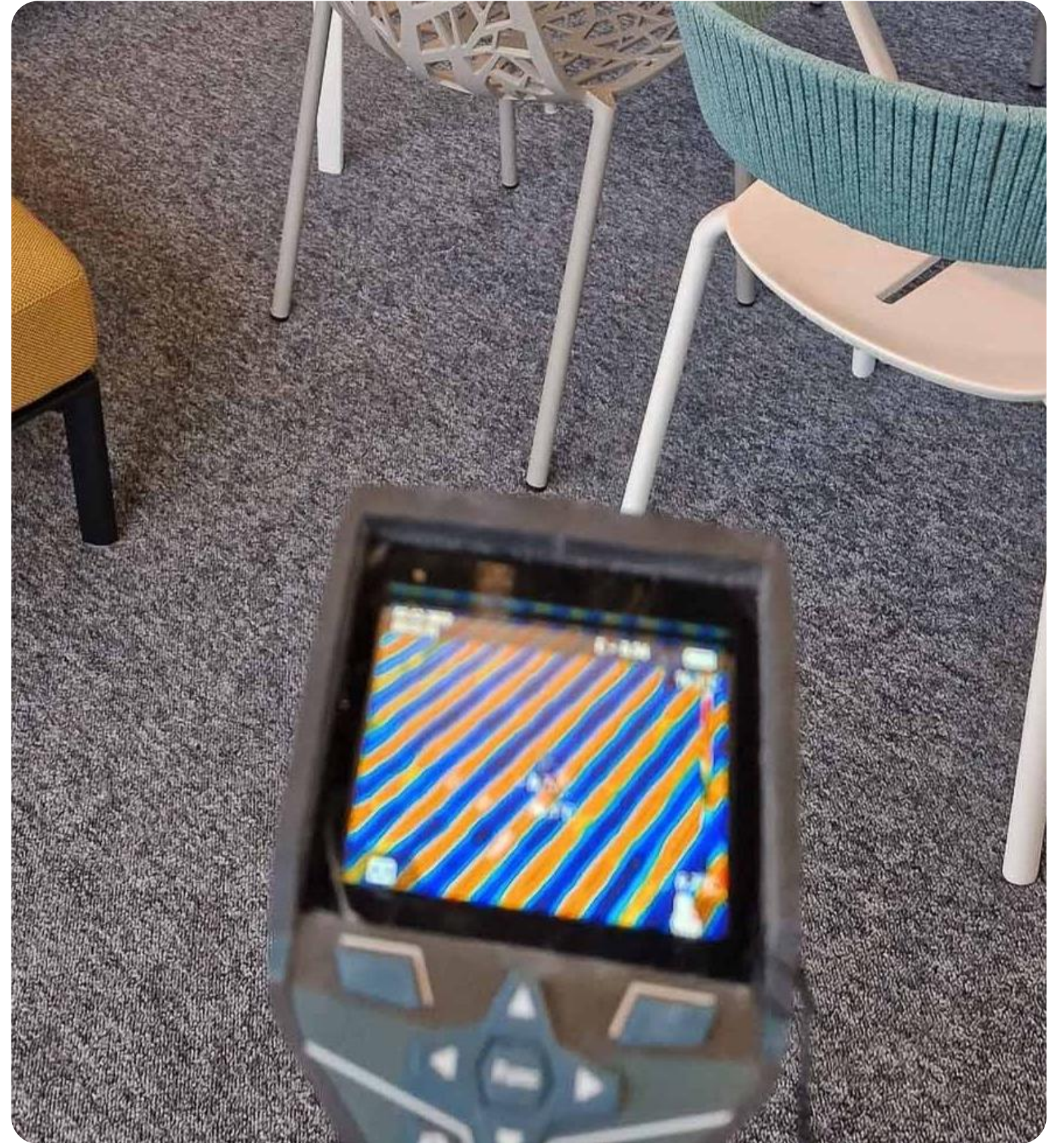

SOLUZIONI RADIANTI IN FIBRA DI CARBONIO

[www.lab44.it](http://www.lab44.it)



## CASE HISTORY

# CHIESA DELL'IMMACOLATA

Padova



SOLUZIONI RADIANTI IN FIBRA DI CARBONIO

[www.lab44.it](http://www.lab44.it)



## CASE HISTORY

COMMERCIALI  
E  
RESIDENZIALI

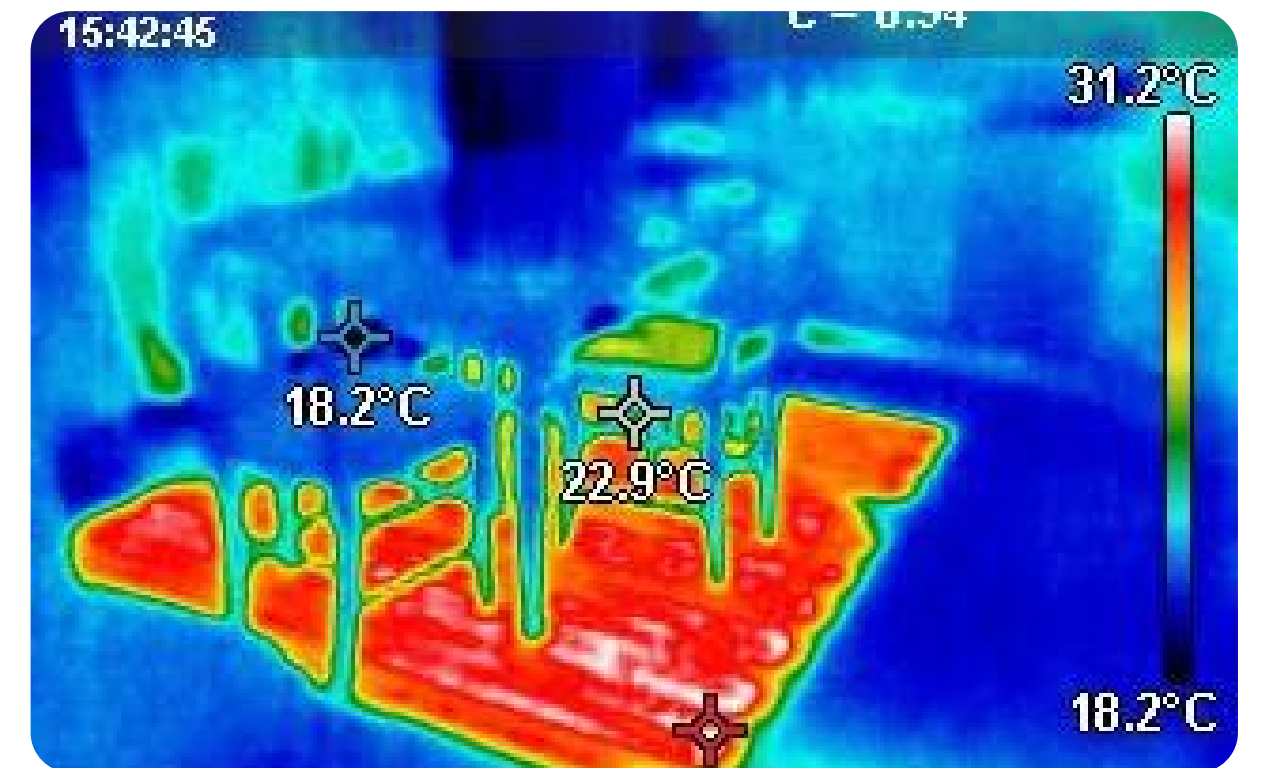
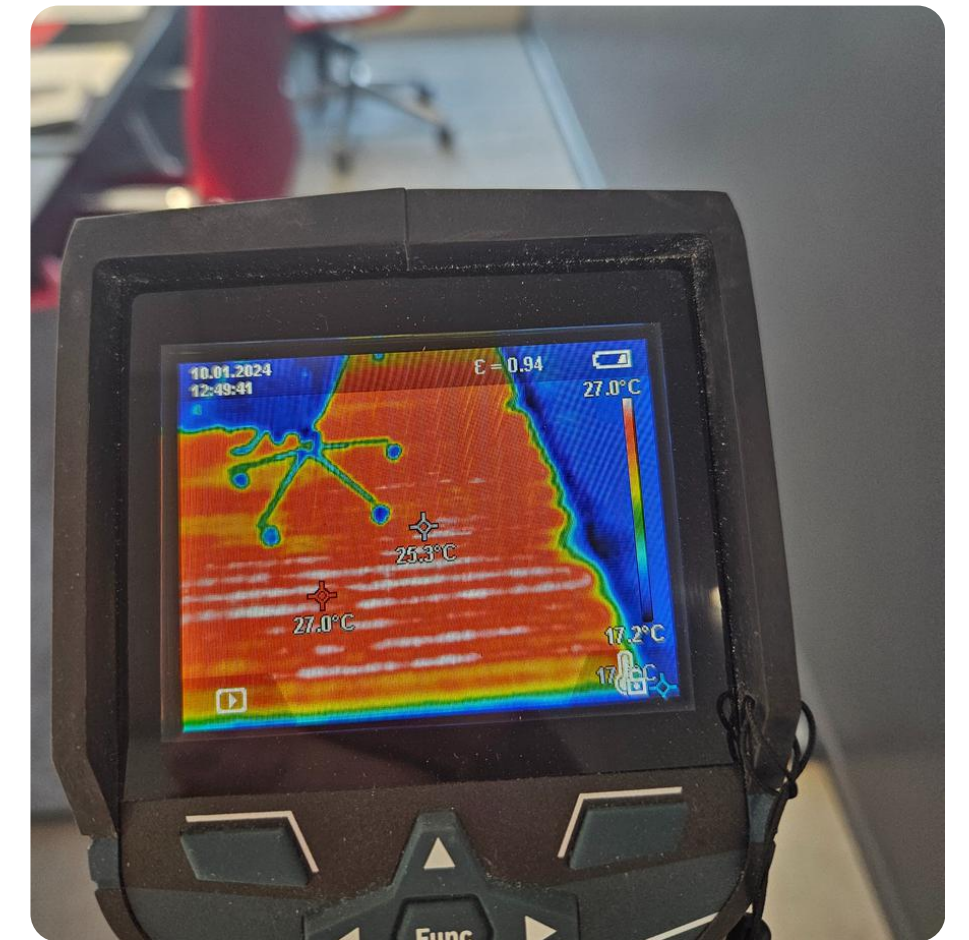

SOLUZIONI RADIANTI IN FIBRA DI CARBONIO

[www.lab44.it](http://www.lab44.it)





SOLUZIONI RADIANTI  
IN FIBRA DI CARBONIO

[www.lab44.it](http://www.lab44.it)